

HESSAPP

DVT SERIES

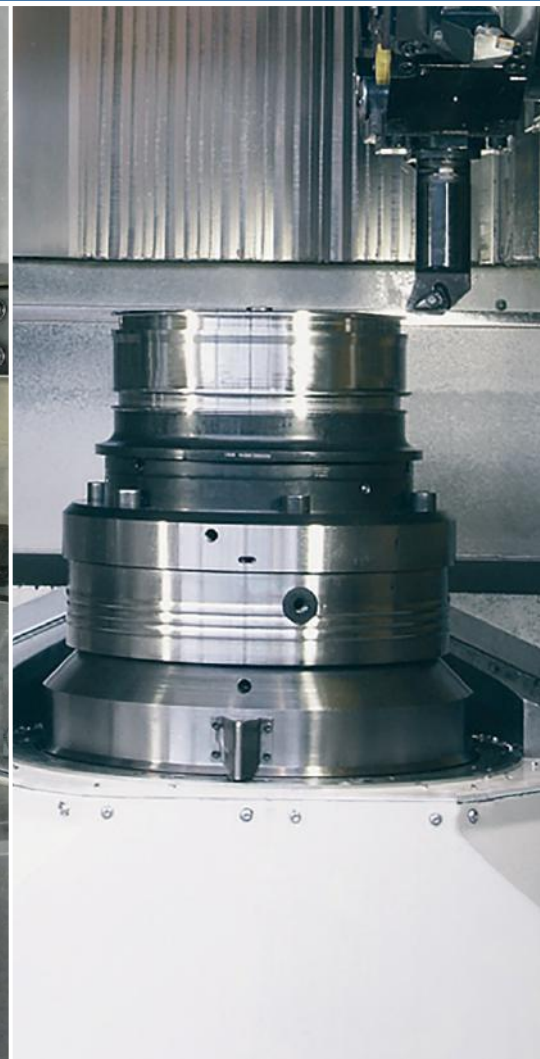

Pick-up Vertical Turning Machines with Transfer Technology



The Compact Production Turning Machine

Unique machine design

The proprietary Hessapp DVT design stands for complete machining without compromise, combined with maximum precision. When it comes to high precision in one chucking after another, in particular, the advantages are significant, because the workpiece is transferred to the next chuck still clamped, without losing its position. Ever more restricted production floor space requires a compact machine design. Compared to the footprint of two individual machines with interlinking and turnover station, the advantages of the DVT are especially obvious. The ergonomic machine design with

large doors and windows guarantees maximum user friendliness, easy setup and fixturing. As the turnover station is dispensed with, automation setup times are also minimized.

Technologies

- ▶ Turning
- ▶ Drilling
- ▶ Milling
- ▶ Grinding
- ▶ Hard turning

Industries

- ▶ General mechanical engineering
- ▶ Aerospace
- ▶ Automotive
- ▶ Commercial Vehicles
- ▶ Construction Machinery
- ▶ Fittings



Advantages

Innovative transfer technology

- ▶ Automatic loading / unloading of the machine
- ▶ Workpiece transfer with maximum positioning accuracy
- ▶ Machining process layout according to the specific advantages of a suspended and a fixed spindle regarding gravity and chip fall
- ▶ No conveyors or turnover stations between the first and second chucking operations
- ▶ High axis speeds for low cycle times and minimal non-productive times
- ▶ Low cost through high productivity

Components and options

- ▶ Simple, reliable, tried-and-tested components
- ▶ Numerous options for your individual DVT
- ▶ Highly versatile
- ▶ Short setup times
- ▶ Rapid installation and production start-up

Excellent ergonomics

- ▶ Easily accessible, generous work area
- ▶ Unlimited freedom of movement
- ▶ Easy setup, keeping idle times to a minimum
- ▶ Large window for observing the manufacturing process

Problem-free handling systems

- ▶ Self-loading / unloading
- ▶ No loaders required
- ▶ Easy changeover to different workpiece diameters
- ▶ Problem-free linking to other equipment

Extract from the workpiece range



Functional Design – Transfer Technology

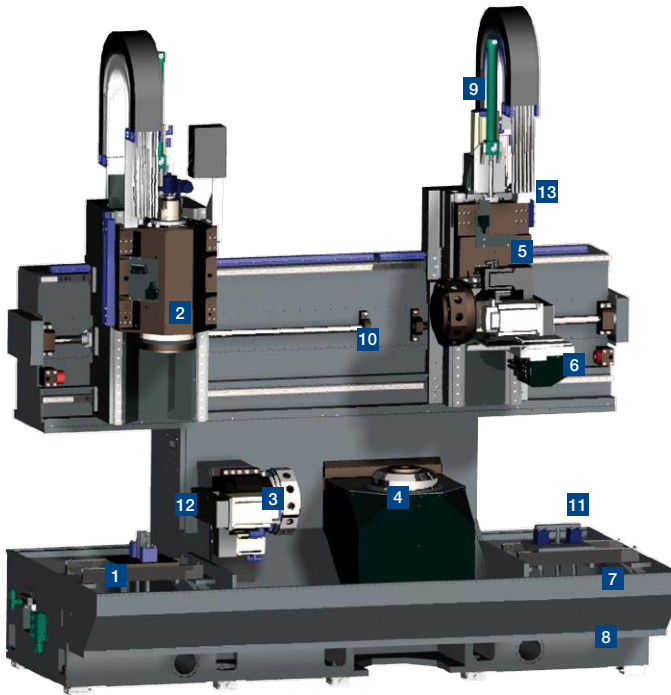

DVT – Standard configuration

- 1 Workpiece infeed conveyor
- 2 Travelling (suspended) motor spindle
- 3 Stationary turret head
- 4 Fixed motor spindle
- 5 Cross slide
- 6 Workpiece gripper for unloading
- 7 Workpiece outfeed conveyor
- 8 Tray-type enclosure
- 9 Hydraulic counter-balancing
- 10 Ball screw drive
- 11 Hydraulic lift unit with run-over protection
- 12 Y-axis
- 13 Linear measuring systems in all axes

DVT 200 / 300 / 400 also available as mirrored configuration

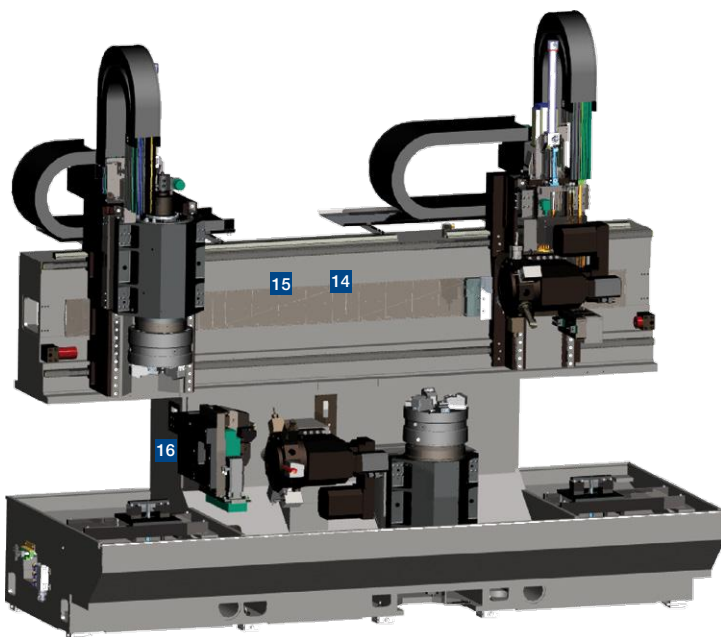

DVT Auxiliary components

- 14 Linear drive
- 15 Linear guides with integrated measuring systems
- 16 Technology modules for grinding, NC-slide, drilling, milling

DVT 500 / 630 / 750 also available as mirrored configuration

Complete Machining of Two Workpieces without Turnover Device

The uniqueness of the DVT

Instead of two individual machines linked by handling and turnover stations, just one DVT is required for machining workpieces from two sides with maximum precision. The basis for this system is the automatic loading of the machine through the suspended spindle and machining in an enclosed work area. Direct transfer to the chuck of the fixed spindle after machining takes place without any loss of quality between the two chucking operations.

While the second side is being machined, the suspended spindle is loaded once more and machining continues without interruption. The fixed spindle is unloaded by a separate gripper. The finished component is removed by an integrated handling device, so that blank and finished parts are clearly separated for the operator.



Step 1: Load



Step 2: Machine 1st side



Step 3: Transfer workpiece



Step 4: Machine 2nd side

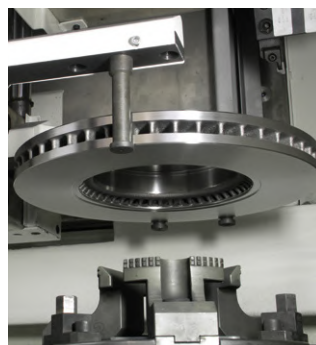

Step 5: Unload

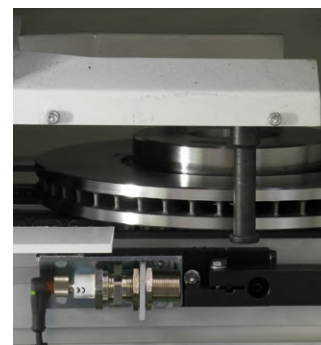

Step 6: Stack

Modular System



Motor spindle

- ▶ max. 42 kW (40 % duty)
- ▶ max. 5000 rpm



Motor spindle

- ▶ max. 71 kW (40 % duty)
- ▶ max. 4000 rpm



Motor spindle

- ▶ max. 80 kW (40 % duty)
- ▶ max. 4000 rpm



Multiple drill head

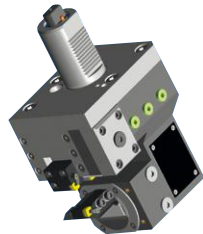

**Tool holder with
NC lift-off slide**



Crown turret

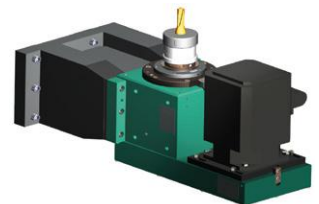

Drilling/milling unit

- ▶ 100 Nm / 3000 rpm
- ▶ B-axis*



Turret with live tools

- ▶ 100 Nm / 4000 rpm
- ▶ 250 mm tool length

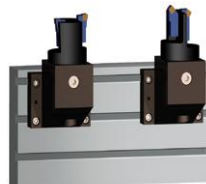

Multifunction plate

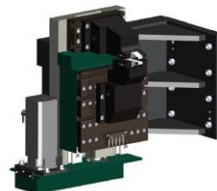

NC lift-off slide

- ▶ Stroke max. 40 mm
- ▶ For holding static tools
- ▶ Workpieces up to Ø 500 mm

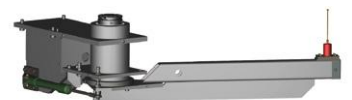

Workpiece gauge



Oval conveyor belt drag conveyor



Inverted-tooth chain driven conveyor



Flat chain driven conveyor

Standard Options

Machine bed

- ▶ Intrinsically robust machine base
- ▶ Strong-walled, extensively ribbed structure
- ▶ Short strokes keep idle times to a minimum
- ▶ Use of driven tools
- ▶ Linear measuring system with pneumatic overpressure in the X-axis
- ▶ Machine bed available as mineral casting
- ▶ Integrated measuring system in X-axis

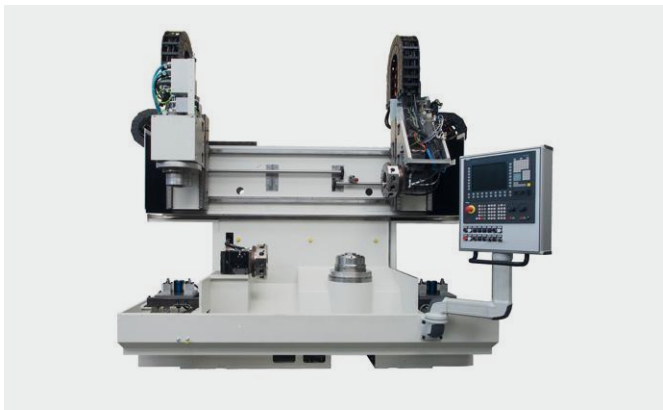

Machine bed and cross slide

Highly dynamic motor spindles

- ▶ High speed
- ▶ High motor power
- ▶ Liquid-cooled, ensuring high thermal stability and low noise
- ▶ Exact positioning through integrated C-axis
- ▶ Integrated clamping stroke monitoring reduces setup requirements



Highly dynamic motor spindles

Options:

CNC controls

- ▶ SIEMENS
- ▶ FANUC

SIEMENS
FANUC

Handling systems

- ▶ Drag conveyor
- ▶ Inverted-tooth chain driven conveyor
- ▶ Pallet conveyor
- ▶ Oval conveyor

Clamping/fixture options

- ▶ Oil filled for low maintenance
- ▶ Quick jaw change
- ▶ Clamping device exchange support

Optional technology

- ▶ B-axis (on request)
- ▶ Drilling/milling unit
- ▶ NC lift-off slide
- ▶ Multifunction plate
- ▶ Turret with static tool
- ▶ Turret with driven tool
- ▶ Special chucks
- ▶ Workpiece/tool gauging
- ▶ Y-axis +/- 75 mm
- ▶ NC lift-off tool in turret

Chip disposal/coolant

- ▶ Scraper chip conveyor
- ▶ Hinged chip conveyor
- ▶ Coolant tank 950 l
- ▶ Paper belt filter
- ▶ Edge filter
- ▶ Heat exchanger
- ▶ Extractor
- ▶ High pressure coolant 80 bar

DVT Models

Advantages

- ▶ Powerful motor spindles
- ▶ Fast axis speeds
- ▶ Configuration from modular system
- ▶ Various chip conveyors and cooling systems (high pressure)
- ▶ Selection of different tools and tool carrier systems
- ▶ Despite the compact work area, all machine components – such as the spindle, chuck and tool turret – can be easily reached for setup work

DVT 200/300

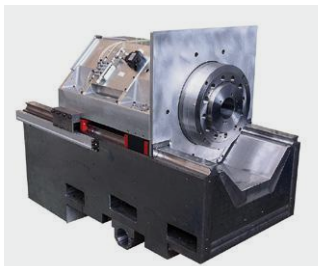

Highly dynamic motor spindles as plug & play components



Slide version with 12-unit turret as technology carrier

- ▶ For workpieces with a swing diameter of up to 250/280 mm
- ▶ Access to entire work area through one large door, large windows
- ▶ Electric turret drive for minimal thermal effects
- ▶ Y-axis +/- 75 mm as option
- ▶ The multifunction plate offers space for various machining modules, such as drilling, milling and grinding

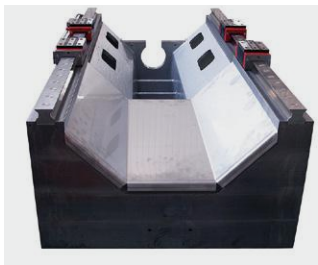

Thermo-symmetrical construction



Multifunction plate as a low-cost alternative to the turret (DVT 300)

Technical Data

		DVT 200	DVT 300
Work area			
Turning diameter max.	mm	200	300
Swing diameter max.	mm	260	320
Workpiece height with chuck	mm	318	320

DVT 400 / 500



- ▶ For workpieces with a swing diameter of up to 510 mm
- ▶ The DVT 500 also offers space for various machining modules, such as drilling, milling and grinding
- ▶ The diverse options available are rounded off by an integrated Y-axis, tool and workpiece gauging, and driven tools with internal coolant supply
- ▶ Modular tooling systems suitable for high pressure cooling up to 80 bar

Technical Data

		DVT 400	DVT 500
Work area			
Turning diameter max.	mm	450	500
Swing diameter max.	mm	510	510
Workpiece height		470 US/	470 US/
with chuck	mm	360 – 420 LS*	355 – 475 LS*

*US = upper motor spindle / LS = lower motor spindle

DVT 630 / 750



- ▶ For workpieces with a swing diameter of up to 630/750 mm
- ▶ Steep gradient of the walls in the work area guarantees the best chip removal
- ▶ Lower spindle can be configured as travelling motor spindle
- ▶ Automation options for large and heavy parts

Technical Data

		DVT 630	DVT 750
Work area			
Turning diameter max.	mm	570	630
Swing diameter max.	mm	630	750
Workpiece height with chuck	mm	450	500

Components and Options for Your Individual Machine

Drilling/milling unit

The modular drilling / milling unit can be used both for individual tools and multiple drill heads.

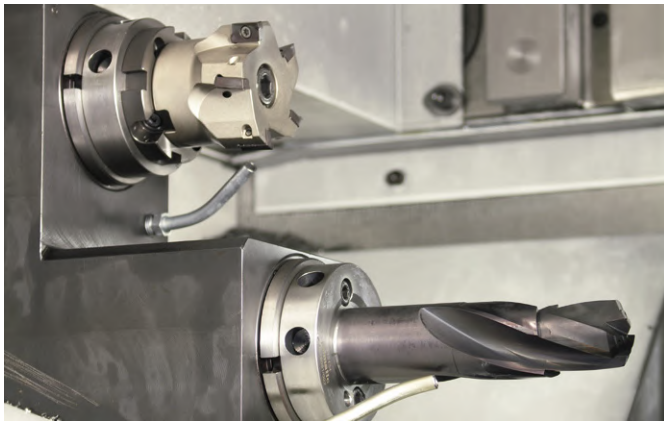

Technical Data

Performance class 1

Speed max.	rpm	4500
Torque	Nm	40
Power	kW	20

Performance class 2

Speed max.	rpm	3000
Torque	Nm	100
Power	kW	23

Driven tools

Turning, drilling, milling and tapping in a single chucking offers the best machining quality. No setup is needed between operations and the number of fixtures required is reduced. To reduce the clamping pressure, the workpiece is supported by a fixture integrated in the turret.

NC lift-off slide with tool

The NC lift-off slide was specially developed for the manufacture of brake disks. It can be employed for the machining of all plane surfaces, however. Two cutters can operate simultaneously.

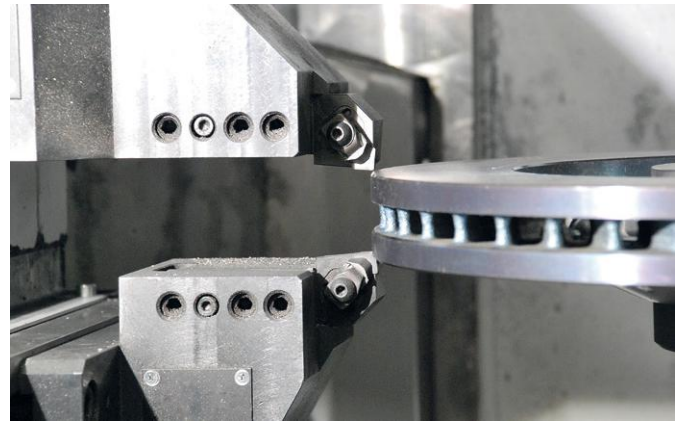

Technical Data

Stroke	±20 mm
T-slot	DIN 650
	a = 14 mm
	b = 23 mm
	c = 9 mm
Slot distance	DIN 55200
	100 mm

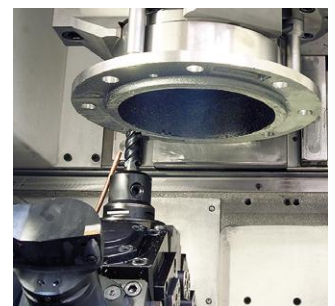

Material Handling Systems – Flexible, Trouble-free, Adapted to the Job



DVT 200 with rotary conveyor in a gear manufacturing cell with integrated robot automation and subsequent gear machining on a Modul hobbing machine

Flexible handling systems

Our technical partnership with you begins with your workpiece, your machining challenges, quality and output requirements. From these individual elements, we develop a process that revolves around your workpiece, in every sense of the word. The end result is your own tailor-made vertical turning machine. The DVT machine series is ideal for complete machining, and can be expanded for use in automated turning cells and lines. For complete machining of brake discs including roughing and

finishing operations, as well as optional grinding, drilling, and milling, Hessapp offers turnkey solutions consisting of a DVH and a DVT machine or two DVT machines. Whether you are looking at multiple machine operation, production through break times or in shifts with minimal staffing, a comprehensive range of equipment is available for whichever degree of flexibility and automation you require.

This includes equipment for workpiece identification, loading, gauging and monitoring.

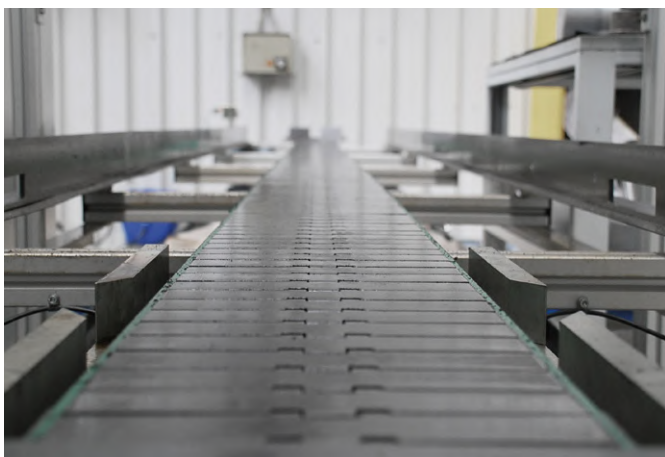

Flat chain driven conveyor

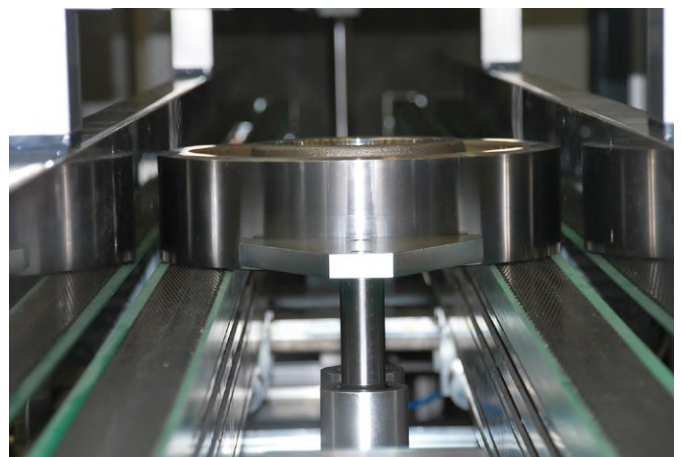

Chain driven conveyor

Technical Data

Machine type		DVT 200	DVT 300	DVT 400
Work area				
Turning diameter max.	mm	200	300	450
Swing diameter max.	mm	260	320	510
Workpiece height with chuck	mm	318	320	470 US / 360 – 420 LS*
Motor spindle				
Front bearing diameter	mm	100	100	150
Spindle nose	DIN	55 026	55 026	55 026
Spindle nose cylindrical (spindle taper)	size	A6	A6	A11
Speed max.	rpm	5500	5500	4000
Motor power at 40 % duty	kW	34	34	80
Torque at 40 % duty	Nm	360	360	795
Feed rate/rapid traverse				
Rapid traverse Z-axis	m/min	30	30	30
Rapid traverse X-axis	m/min	60	60	60
Tool turret				
Tool positions	number	12	12	12
Cylinder shank ø mm	DIN 69880	40	40	50
Tool length max.	mm	180	200	250
Machine foot print				
Dimensions L x W x H	m	4.0 x 2.4 x 3.1	4.4 x 2.4 x 3.1	3.8 x 2.7 x 3.8
Weight	kg	11 500	12 100	16 000

* US = Upper spindle / LS = Lower spindle



Machine type		DVT 500	DVT 630	DVT 750
Work area				
Turning diameter max.	mm	500	570	630
Swing diameter max.	mm	510	630	750
Workpiece height with chuck	mm	470 US / 355 – 475 LS*	450	600
Motor spindle				
Front bearing diameter	mm	150	180	220
Spindle nose	DIN	55026	55026	55026
Spindle nose cylindrical (spindle taper)	size	A11	A11	A15
Speed max.	rpm	4000	2800 / 800	2000 / 800
Motor power at 40% duty	kW	80	80 / 68	55 / 68
Torque at 40% duty	Nm	795	1150 / 2950	1780 / 2950
Feed rate/rapid traverse				
Rapid traverse Z-axis	m/min	30	30	20
Rapid traverse X-axis	m/min	60 / 90	45 / 60	20
Tool turret				
Tool positions	number	12	12	8
Cylinder shank ø mm	DIN 69880	50	50	60
Tool length max.	mm	260	270	300
Machine foot print				
Dimensions L x W x H	m	4.6 x 2.7 x 3.8	5.7 x 2.6 x 3.6	5.8 x 2.6 x 3.9
Weight	kg	18 000	20 000	30 000

Subject to change without notice

OEM Service for our Brands and Legacy Brands

VDF BOEHRINGER **NAG** **LEADWELL**



Service Center Goeppingen
Goeppinger Strasse 50, DE-73033 Goeppingen
Tel.: +49 7161 201-0

JOBS **RAMBAUDI** **SACHMAN**



Jobs GmbH
Aindlinger Strasse 3, 86167 DE-Augsburg
Tel.: +49 821 5976 630

HESSAPP



Service Center Taunusstein
Aarstrasse 157, DE-65232 Taunusstein
Tel.: +49 6128 243 260

MODUL



Service Center Chemnitz
Marienberger Strasse 17, DE-09125 Chemnitz
Tel.: +49 371 576 386

Honsberg

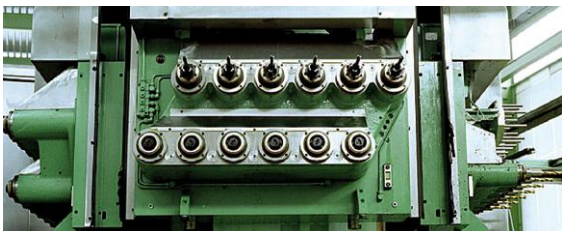

Service Center North/West
Stefansbecke 30, DE-45549 Sprockhoevel
Tel.: +49 2339 9278 0

Pfiffner



K.R. Pfiffner AG, Utzenstorf
Sonnemattstrasse 28, CH-3427 Utzenstorf
Tel.: +41 32 666 35 35

WITZIG & FRANK



Service Center Offenburg
Am Holderstock 2, DE-77652 Offenburg
Tel.: +49 781 289 1121



FFG 24/7 Service and Support:
www.ffg-werke.com/24x7

Service and support

- ▶ Commissioning
- ▶ Maintenance and inspections
- ▶ Repair service
- ▶ Spindle service
- ▶ Overhaul and retrofit
- ▶ Used machines
- ▶ Service contracts
- ▶ Machine relocation



Process and production optimization

- ▶ Process optimization
- ▶ Programming
- ▶ Software: machine data acquisition, diagnosis, condition monitoring, energy management, virtual machine

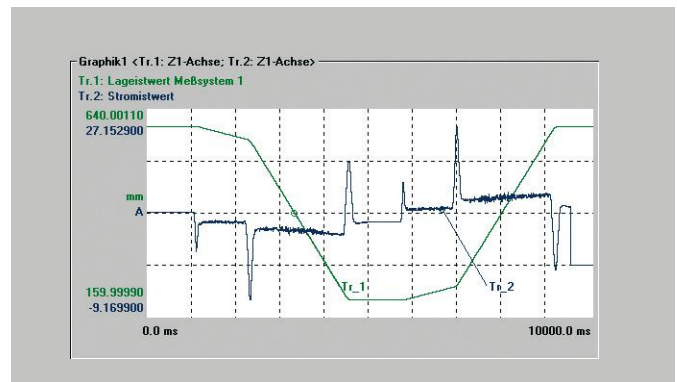
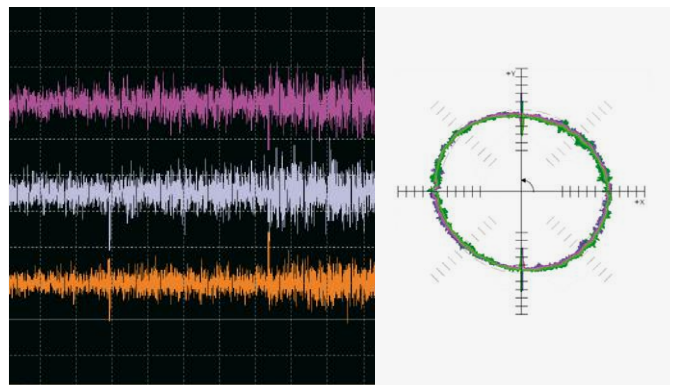

Machine condition monitoring "Finger print" via vibration analysis, ballbar test and trace measurement.

Spare parts

- ▶ 24/7 delivery
- ▶ Central warehouse
- ▶ Individual service concepts



Training

- ▶ Operator training
- ▶ Maintenance training (mechanical, electrical)
- ▶ Programming training



VDF BOEHRINGER

HESSAPP



meccanodora



MORARA



TACCHELLA

WITZIG & FRANK

About FFG Europe & Americas

The FFG entities in Europe and the Americas unite major players from the German, Italian, Swiss and American machine tool industry with a broad range of milling, turning, grinding, and gear manufacturing technology, and the knowhow of the renowned machine tool brands VDF Boehringer, Hessapp, IMAS, Jobs, MAG, Meccanodora, Modul, Morara, Pfiffner, Rambaudi, Sachman, Sigma, SMS, Tacchella and Witzig & Frank. Since 1798, these brands have substantially contributed to the progress in industrial manufacturing and are well known as reliable and innovative equipment and systems solutions suppliers for the automotive and truck, aerospace, machine building, general machining, railway industry, energy and heavy engineering industries. While being an independent group, these entities benefit from the strengths and opportunities of the global Fair Friend Group. They stand for premium technology within FFG.

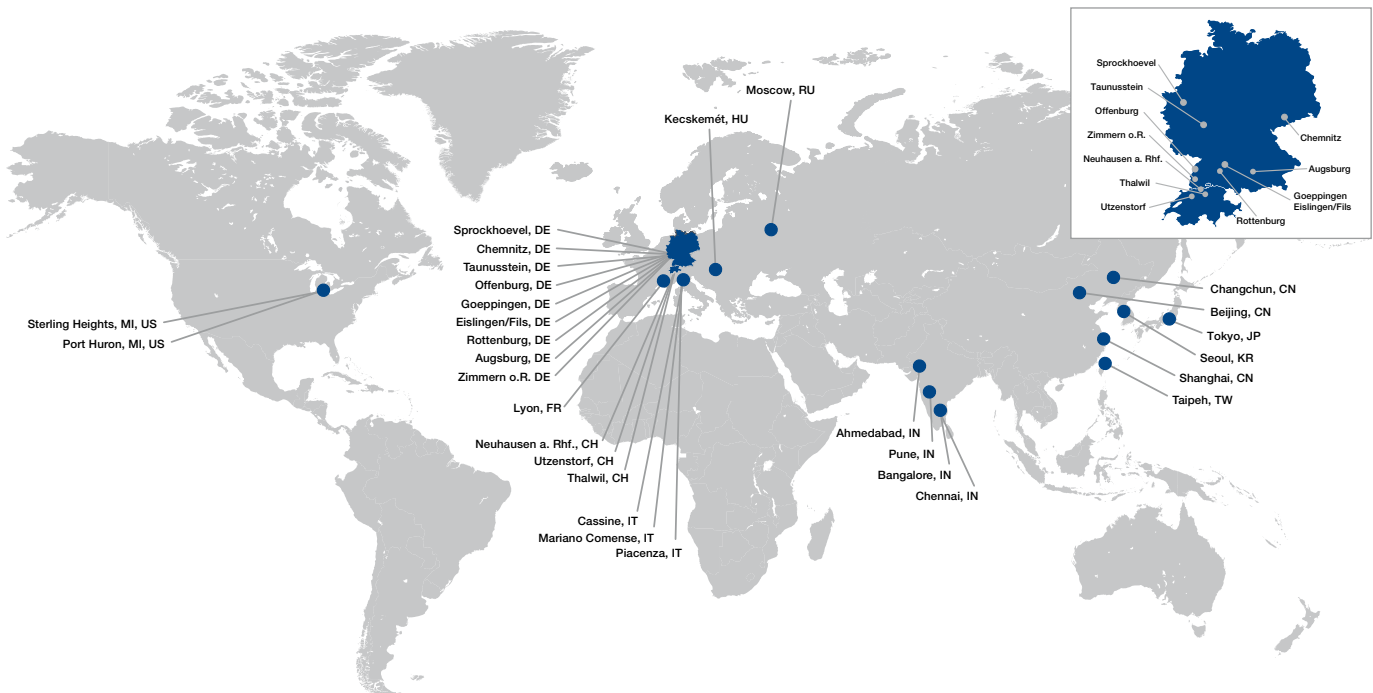

FFG Europe & Americas

FFG Werke GmbH
Aarstrasse 157
DE-65232 Taunusstein-Hahn
Tel. +49 61 28 243-0
Fax +49 61 28 243-111

HE2101(02DE)en/600/09.17

FFG Werke GmbH

info@ffg-werke.com

www.ffg-werke.com



FFG 24/7 Service and Support: www.ffg-werke.com/24x7



Made in Germany since 1789