

# HORIZ ONTAL MACHIN ING CENTERS

---

**NBH** SERIES

ZUSE **HÜLLER HILLE**  
WERKZEUGMASCHINEN

# THE 3RD GENERATION NBH MACHINING CENTERS

ADDED VALUE FROM OVER 40 YEARS NBH SERIES

## NBH – RUGGED, PRODUCTIVE AND MADE TO LAST

With decades of success, the NBH series has now been updated according to modular design principles, available in pallet sizes from 500 x 500 mm up to 1000 x 1250 mm. The new series adds state of the art design, technology and control features, adding a new chapter to more than 40 years of machining center expertise.

Traditionally, the letters NBH stood for quality and performance in production, which were now even enhanced regarding ruggedness, productivity and endurance. The new models were designed for increased output and lower cost per part, best-in-class availability, excellent maintainability and maximum application and manufacturing flexibility. They are ideally suited for high volume automotive and tier supplier applications as well as mid-range, small and single part industrial production.

## DISTINCTIVELY NBH – ADVANTAGES OF THE NBH MACHINING CENTERS

- Modular design with a variety of table, spindle and tool magazine options allows you to configure the machine according to your needs
- Reduced positioning and idle times due to high rapid traverse rates up to 90 m/min and rotary table positioning up to 80 rpm
- Robust guideway system with large ball screws, bearings and guideways, and backlash-free, preloaded guiding units, as well as a heavy machine bed for long-term precise heavy duty machining
- Digital drives with maintenance-free, brushless, digitally controlled three-phase servo motors in completely closed design
- High-performance geared spindle up to 2600 Nm torque
- Direct loading of the NBH machining centers without pallet changer, optimal use as system machine in automotive segment
- Easy upgrading for flexible production cells and system
  - Multi-pallet storage system
  - Linear and multi-level pallet storage system
  - Robot and gantry loader automation

## APPLICATION RANGE OF THE NBH RANGE

- High volume production with short cycle times, including multiple clamping fixtures
- Mid range-, small series and single part production
- Complete machining
- Fully-automated production, including process monitoring
- Heavy machining
- Large part machining

# 4-AXIS MACHINING CENTERS



NBH 5 / NBH 500



NBH 6 / NBH 630

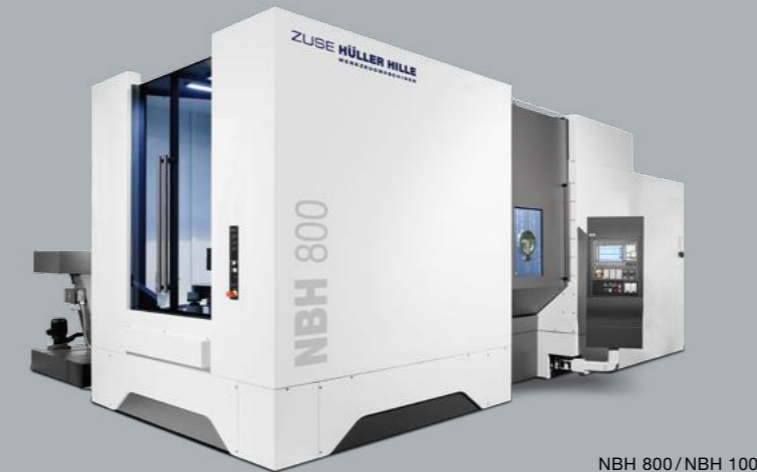

NBH 800 / NBH 1000



NBH 1200



**YOUR ADVANTAGES AT A GLANCE**

- Machine concept tailored towards optimized part costs
- Configure the NBH machine in line with your specific requirements
- Robust machine design ensures reliable, long-lasting-precision in production
- Excellent accessibility to all modules provides easy setup, operation and service
- High technology competence



Enhanced machine utilization with the original rack-type cassette magazine for incycle changing sets of 50 tools by means of a cassette carriage in just a few minutes.

# 5-AXIS

## HORIZONTAL MACHINING CENTERS



NBH 630 5X/800 5X (swivel head)



NBH 800 5X/1000 5X (tilting/rotary table)



NBH 1000 5X (Clevis)

# NBH 5/500

THE ENTRY-TYPE NBH WITH PALLET SIZE 500 X 500 MM



The NBH 5 / NBH 500 with a pallet size of 500 x 500 mm is the entry-type model of the high performance NBH series. With 466 Nm torque (at 100% duty), it is at the top of its class (NBH 500).

As a universally applicable allrounder, the configurations feature a wide variety of motor and geared spindles, covering the speeds and torque ranges for a vast range of applications. The choice of tool magazines adds to this universality with production proven disc-, chain- and rack-type magazines.

The machining centers including 180 deg pallet changer and tool magazine are designed as single, compact transport unit. This guarantees easy installation and set-up for a quick start of production.

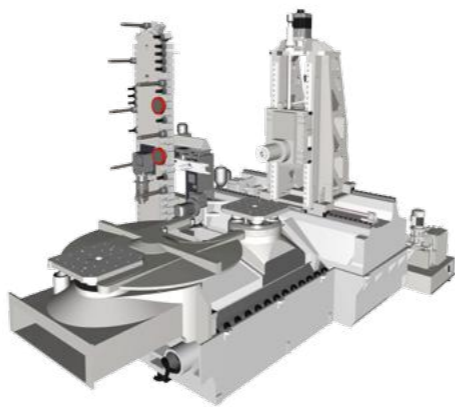

NBH 500 with geared spindle [option] and chain magazine with 60 tool locations [option]. For details see page 18/19.

### ADVANTAGES OF THE NBH 5/500

- High accuracy through jig boring mill axis arrangement (i.e. Z-axis in workpiece)
- High torque through geared headstock (except NBH 5)
  - Economical machining of steel and cast iron
  - Spindle speed 10 000 rpm suited for mixed machining with aluminum materials
- For light metal machining high-speed motor spindle up to 16 000 rpm
- Large choice of tool magazines and sizes suiting your individual production requirements
- Easy upgrading for flexible production cells and systems
  - Multi-pallet storage system
  - Linear and multi-level pallet storage system
  - Robot and gantry loader automation



Two levels of X-axis guideways for maximum absorption of cutting forces

### SINGLE CAST, SELF-SUPPORTING MACHINE BED

- Heavily ribbed, one-piece casting with high damping characteristics
- Two levels of X-axis guideways for optimized column support and maximum absorption of cutting forces
- Extremely rigid

### GUIDEWAYS

- Backlash-free form rail guidance and absolute space-coded direct position measuring systems in all linear axes, optional glass scales
- High rigidity and stick-slip free axis movement

### DIGITAL DRIVES

- Acceleration 8 m/s<sup>2</sup>, rapid traverse 65 m/min
- Option speed package: Acceleration 10 m/s<sup>2</sup>, rapid traverse 90 m/min (NBH 5)



Compact, one-piece and rigid machine bed

### SAFE AND EASY CHIP REMOVAL

- Free chip fall
- Optimized chip disposal via two chip grooves integrated in machine bed

### TABLE ASSEMBLY

- Compact cast housing
- Direct driven rotary axis (torque table)
- Rotary speed B-axis 80 rpm
- High positioning accuracy
- 4-cone pallet location with integrated pallet clamping
- Air purge blocks coolant and chips
- Hydraulic clamping [option]



Basic structure of NBH 500 with geared spindle [option] and chain magazine with 60 tool locations [option]

### LOADING STATION AND PALLET CHANGER

- Fast 180° swivel changer, changing time (VDI 2852) approx. 9 s / 11 s (NBH 5 / NBH 500)
- Rotary loading station
- 2-line and 6-line hydraulic clamping [option]
- Set-up during machining cycle

### MODERN, POWERFUL CNC CONTROL

- Siemens Sinumerik 840D sl
- Fanuc Steuerung 0i-F (NBH 5)

### AUTOMATION

- Uncomplicated connection to flexible pallet storage and automation systems

### SHORT INSTALLATION AND COMMISSIONING TIMES

- Compact design allows easy transport and setup by crane
- Single transport unit

### TECHNICAL DATA

[...] = option  
1) = when direct loading

Subject to change without notice

		NBH 5		NBH 500		
Pallet size / clamping surface <sup>1)</sup>	mm	500x500/ø 500		500x500		
Pallet load max. / table load <sup>1)</sup>	kg	500/800		800		
Travel X- / Y- / Z-axis	mm	700/630/700		900/800/900		
Tool locations max.	number	40 [32] [60] [90]		40 [60] [90] [294]		
Speed max.	rpm	10 000	[16 000]	10 000	[16 000]	[10 000]
Spindle power (40% duty)	kW	39	52	39	52	22,5 (100% ED)
Torque max. (40% duty)	Nm	180	125	180	125	466 (100% ED)

# NBH 6/630

THE COMPACT NBH WITH PALLET SIZE  
630 X 630 MM



The integrated design of the NBH 6 / NBH 6+ / NBH 630 provides for a large work area compared to the total exterior measurements. With the machine bed as a one-piece casting, the entire machine is a single transport unit, excluding tool magazine and pallet changer. This means a major reduction of installation and set-up times.

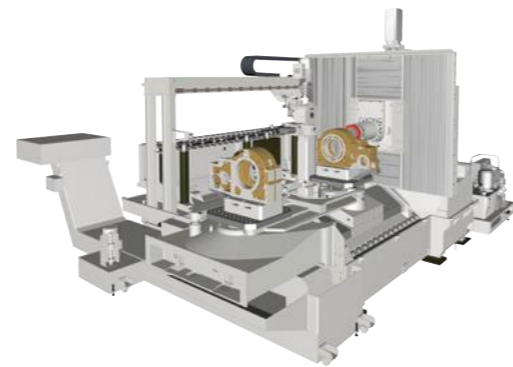

NBH 630 with geared spindle [option] and tool cassette magazine with 150 tool locations [option].

### ADVANTAGES OF THE NBH 6/NBH 630

- High accuracy through jig boring mill axis arrangement (i.e. Z axis in workpiece)
- The large choice of tool magazines with different capacities allows you to configure the machine according to your requirements
- Enhanced machine utilization with the original Hüller Hille rack-type cassette magazine for in cycle changing sets of 50 tools by means of a cassette carriage in just a few minutes (NBH 630)
- Unique comfort tool management (NBH 630)
  - Automatic twin tool strategy
  - Monitoring of tool life quantities
- Practice-oriented tool data, e. g. up to 800 mm long tools
- Easy upgrading for flexible production cells and systems
  - Multi-pallet storage system
  - Linear and multi-level pallet storage system
  - Robot and gantry loader automation



Compact, one-piece and rigid machine bed with two levels of X-axis guideways for maximum absorption of cutting forces

### SINGLE CAST, SELF-SUPPORTING MACHINE BED

- Heavily ribbed, one-piece casting with high damping characteristics
- Two levels of X-axis guideways for optimized column support and maximum absorption of cutting forces
- Extremely rigid

### GUIDEWAYS

- Backlash-free form rail guidance and absolute space-coded direct position measuring systems in all linear axes, optional glass scales
- High rigidity and stick-slip free axis movement

### DIGITAL DRIVES

- Maintenance-free, brushless, digitally controlled three-phase servo motors in completely closed design
- Direct power transmission to precision ball screws
- High acceleration 7 m/s<sup>2</sup> (NBH 630)
- Highly dynamic, high rapid traverse 70 m/min (NBH 630)

### TECHNICAL DATA

[...] = option

Subject to change without notice



Basic structure of NBH 630 with motor spindle and torque table

### SAFE AND EASY CHIP REMOVAL

- Free chip fall
- Optimized chip disposal via two chip grooves integrated in machine bed

### TABLE ASSEMBLY

- Compact cast housing
- Direct driven rotary axis (torque table)
- Rotary speed B-axis 80 rpm
- High positioning accuracy
- 4-cone pallet location with integrated pallet clamping
- Air purge blocks coolant and chips
- Hydraulic clamping [option]



Fast 180° swivel changer

### LOADING STATION AND PALLET CHANGER

- Fast 180° swivel changer, changing time (VDI 2852 approx. 13 s)
- Rotary loading station
- 2-line and 6-line hydraulic clamping [option]
- Set-up during machining cycle

### MODERN, POWERFUL CNC CONTROL

- Siemens Sinumerik 840D sl

### AUTOMATION

- Uncomplicated connection to flexible pallet storage and automation systems

### SHORT INSTALLATION AND COMMISSIONING TIMES

- Compact design allows easy transport and set-up by crane

		NBH 6			NBH 630		
Pallet size	mm	630x630			630x630 [800x800]		
Pallet load max.	kg	1000			1500		
Travel X- / Y- / Z-axis	mm	800/800/800			1025/800 [1000]/1000		
Tool locations max.	number	60 [120]			60 [120] [150] [200] [300]		
Speed max.	rpm	8000	[12 000]	[10 000]	8000	[12 000]	[10 000]
Spindle power (40% duty)	kW	66	66	46	66	66	46
Torque max. (40% duty)	Nm	370	370	1130	370	370	1130

# NBH 800/1000

THE RUGGED NBH FOR TOP PRODUCTIVITY  
HEAVY DUTY MACHINING

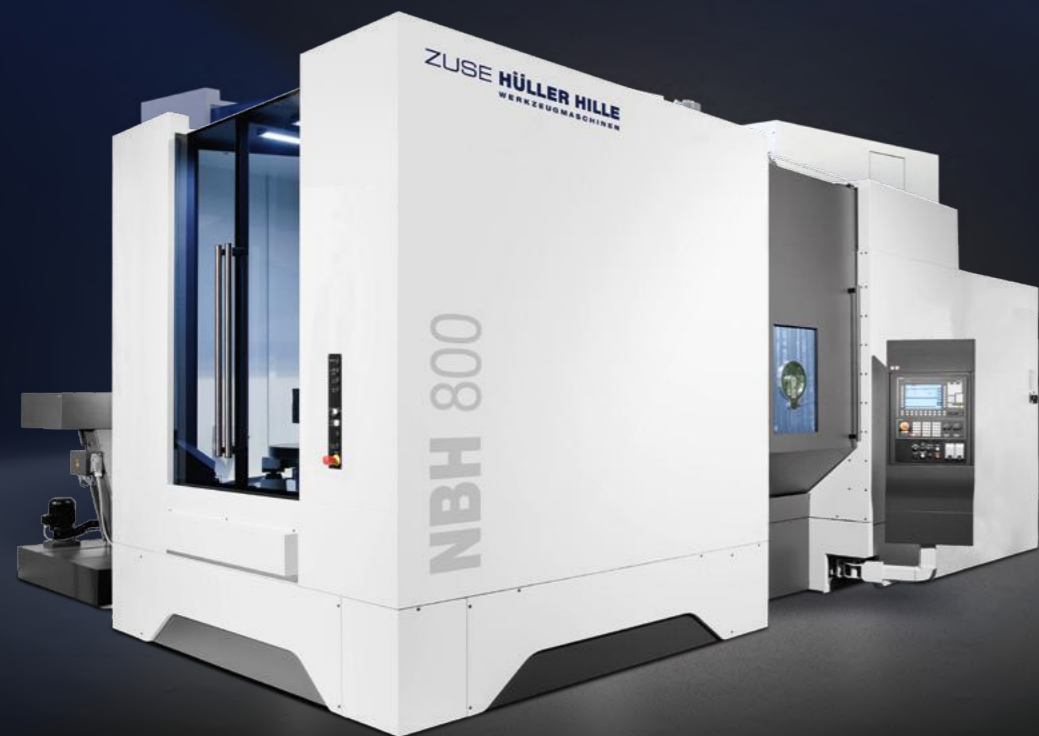

NBH 800 with geared spindle [option] and tool cassette magazine with 150 tool locations [option]

### ADVANTAGES OF THE NBH 800/NBH 1000

- High accuracy through jig boring mill axis arrangement (i.e. Z-axis in workpiece)
- Significant reduction of pallet change time by 180° swivel changer
- High-performance geared spindle with 80 kW spindle power and 2600 Nm torque at 40 % duty
- The large choice of tool magazines with different capacities allows you to configure the machine according to your requirements
- Enhanced machine utilization with the original Hüller Hille rack-type cassette magazine for in cycle changing sets of 50 tools by means of a cassette carriage in just a few minutes
- Unique comfort tool management
  - Automatic twin tool strategy
  - Monitoring of tool life quantities
- Practice-oriented tool data, e. g. up to 800 mm long tools
- Easy upgrading for flexible production cells and systems
  - Multi-pallet storage system
  - Linear and multi-level pallet storage system
  - Robot and gantry loader automation

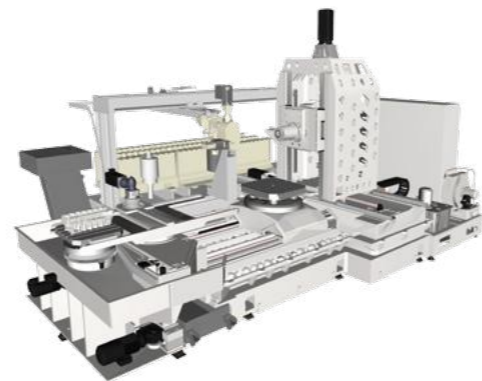

One-piece and rigid machine bed with gantry-driven Z-axis

### SINGLE CAST MACHINE BED

- Heavily ribbed, one-piece casting with high damping characteristics
- Extreme rigidity and low design

### MACHINE COLUMN

- Double-walled and extensively ribbed casting
- Thermo-symmetric structure

### GUIDEWAYS

- Backlash-free form rail guidance with absolute, direct position measuring system via glass scale
- High rigidity and stick-slip free axis movements
- Generous space between guideways

### DIGITAL DRIVES

- Maintenance-free, brushless, digitally controlled three-phase servo motors in completely closed design
- Direct power transmission to precision ball screws

### TECHNICAL DATA

[...] = option

Subject to change without notice



Basic structure of NBH 800 / NBH 1000 with double-walled machine column

- Gantry-driven Z-axis

### SAFE AND EASY CHIP REMOVAL

- Free chip fall
- Optimized chip disposal via four chip grooves integrated in machine bed
- Front or rear chip disposal possible for maximum flexibility in shop floor planning

### TABLE ASSEMBLY

- Compact cast housing
- Direct driven rotary axis (torque table)
- High positioning accuracy
- Highly dynamic, high rapid traverse rates
- 4-cone pallet location with integrated pallet clamping
- Air purge blocks coolant and chips
- Hydraulic clamping [option]



Fast 180° swivel changer

### LOADING STATION AND PALLET CHANGER

- Fast 180° swivel changer
- Motor-driven rotating set-up station
- 2-line and 6-line hydraulic clamping [option]
- Setup during machining cycle

### MODERN, POWERFUL CNC CONTROL

- Siemens Sinumerik 840D sl

### AUTOMATION

- Uncomplicated connection to flexible pallet storage and automation systems

		NBH 800				NBH 1000			
Pallet size	mm	800x800 [1000x1000]				1000x1000 [1000x1250]			
Pallet load max.	kg	2000				3000			
Travel X- / Y- / Z-axis	mm	1400/1100 [1400]/1400				1800/1400/1800			
Tool locations max.	number	60 [120] [150] [200] [300]				60 [120] [150] [200] [300]			
Speed max.	rpm	8000	[12 000]	[10 000]	[5000]	8000	[12 000]	[10 000]	[5000]
Spindle power (40% duty)	kW	66	66	46	80	66	66	46	80
Torque max. (40% duty)	Nm	370	370	1130	2600	370	370	1130	2600

The NBH 800 / NBH 1000 are well prepared for tough jobs, providing for safe and productive machining, even when extreme cutting forces occur. A rugged guideway system with generously spaced guideways, combined with the single piece casting machine bed and a double-walled cast column provide for exceptional stability and rigidity.

# NBH 1200

## THE NBH FOR LARGE AND HEAVY WORKPIECES



Due to the size of the NBH 1200, it is equipped with an X and Z machine bed component. These two parts are set up in fixed positions and firmly screwed together. The proven dual part linear pallet changer handles extreme workpiece weights. It can also be configured for direct loading, for example via gantry or robot.

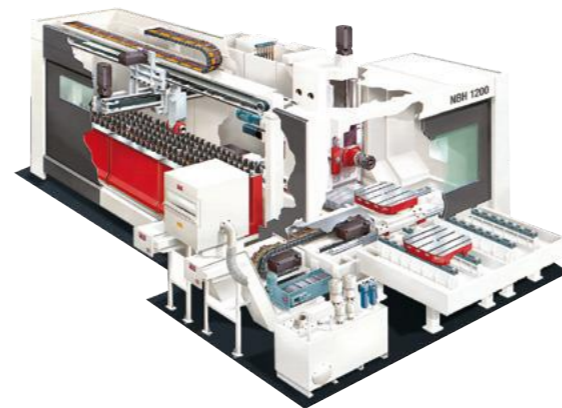

NBH 1200 with linear pallet changer for large and heavy workpieces

### ADVANTAGES OF THE NBH 1200

- With our comprehensive choice of motor and geared spindles with rotational speed variants and wide torque range, the machine can be configured to optimally suit the production requirements
- High-performance geared spindle with 80 kW spindle power and 2600 Nm torque at 40% duty
- Enhanced machine utilization with the original Hüller Hille rack-type cassette magazine for in cycle changing sets of 50 tools by means of a cassette carriage in just a few minutes
- Unique comfort tool management
  - Automatic twin tool strategy
  - Monitoring of tool life quantities
- Practice-oriented tool data for example 650 mm tool length and 50 kg tool weight
- High availability due to the proven machine design, supported by internal and external diagnostic functions
  - Plaintext error display with diagnostic help
  - Plaintext display of service intervals
  - Telediagnostic service
- Easy upgrading for flexible production cells and systems
  - Linear and multi-level pallet storage system
  - Robot and gantry loader automation



The X- and Z-bed are properly positioned and held together with a large-surface bolt connection

### MACHINE BED

- Thick-walled and extensively ribbed casting structure, optimized after the finite element method
- The X- and Z-bed are properly positioned and held together with a large-surface bolt connection

### MACHINE COLUMN

- Thick-walled and extensively ribbed casting
- Closed, torsion and vibration-proof gantry-type column
- Thermo-symmetric structure
- Integrated tool changer

### GUIDEWAYS IN ALL LINEAR AXES

- Backlash-free form rail guidance with absolute, direct position measuring system via glass scale
- High rigidity and stick-slip free axis movements

### TECHNICAL DATA

[...] = option

Subject to change without notice



Basic structure of NBH 1200 with gantry-type column in Z-axis

### DIGITAL DRIVES

- Maintenance-free, brushless, digitally controlled three-phase servo motors in completely closed design
- Direct power transmission to precision ball screws
- High working and rapid traverse speeds at constant positioning accuracy of axes

### SAFE AND EASY CHIP REMOVAL

- Free chip fall
- Optimum chip removal through large chip and return channels for the chip flushing water

### TABLE ASSEMBLY

- Compact cast housing
- Thermo-symmetric structure
- NC rotary table with 0.001° division
- Compressed-air prevents the penetration of coolant and dirt
- Hydraulic clamping [option]

		NBH 1200			
Pallet size	mm	1000x1250			
Pallet load max.	kg	3500 [7000]			
Travel X- / Y- / Z-axis	mm	1800 [2600] / 1250 [1600] / 1400 [1780]			
Tool locations max.	number	100 [150] [200] [300] [400]			
Speed max.	rpm	6000	[10 000]	[5000/7500]	[5000]
Spindle power (40% duty)	kW	46	46	46	80
Torque max. (40% duty)	Nm	1130	1130	1130	2600



Failsafe loading/unloading of heavy workpieces utilizing a proven parallel linear pallet changer

### PARALLEL PALLET CHANGER

- Double pallet changer with linear pallet in-feed thus offering independent loading, unloading and resetting facilities
  - High load capacity (3.5 t [option 7.0 t]) with safe and accurate pallet positioning
  - The largely dimensioned loading and unloading space is protected by automatic doors against coolant and chips ejected from the working area
  - The resetting station is protected by a light barrier
- ### MODERN, POWERFUL CNC CONTROL
- CNC control SINUMERIK 840D sl with "Safety Integrated Software" for safe and practice-oriented set-up works with guard doors opened

# MOTOR AND GEARED SPINDLES

## TAILOR THE MACHINE TO MEET YOUR PRODUCTION REQUIREMENTS

Our comprehensive choice of motor and geared spindles with spindle speeds and torque variants are tailored to real-world manufacturing requirements. The resulting set of configuration options allows you to configure the machine according to your application. Easily changeable motor spindles and geared spindles in tube version provide for a quick and easy service and maintainability.

### ADVANTAGES OF THE MOTOR SPINDLES

- Shorter acceleration and deceleration times
- High maximum speeds
- Smooth running with low vibration characteristics
- Contactless sealing system with compressed-air

### ADVANTAGES OF THE GEARED SPINDLES

- Automatic two-step switching gear
- High concentric running accuracy due to three-bearing support, extremely rigid spindle
- Large bearing diameter (diameter 100 and 130 mm), steel bearing for heavy duty machining available as option
- Long working life through labyrinth seal which in conjunction with compressed-air prevents the penetration of coolant and/or dirt.
- Optimized plunge drilling/milling of complex workpiece geometries and fixtures with the extended and extremely slim spindle tube



### MOTOR SPINDLE

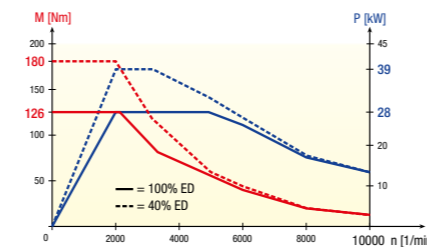

Motor spindle with 80 mm bearing diameter for NBH 5 / NBH 500

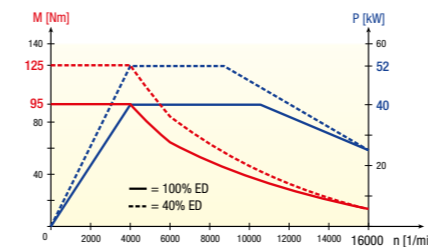

Motor spindle with 80 mm bearing diameter for NBH 5 / NBH 500

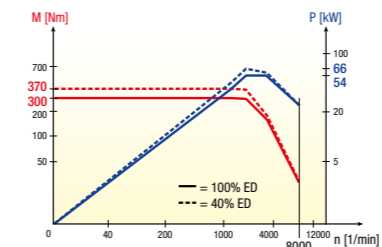

Motor spindle with 100 mm bearing diameter for NBH 6 / 6+ / 630 / 800 / 1000

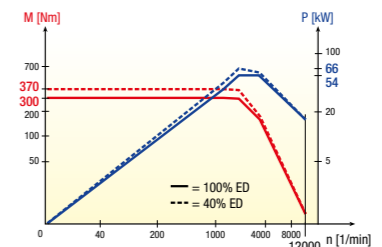

Motor spindle with 100 mm bearing diameter for NBH 6 / 6+ / 630 / 800 / 1000

### GEARED SPINDLE

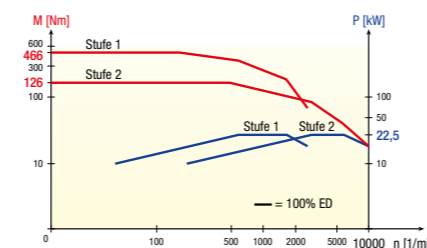

Geared spindle with 80 mm bearing diameter for NBH 500

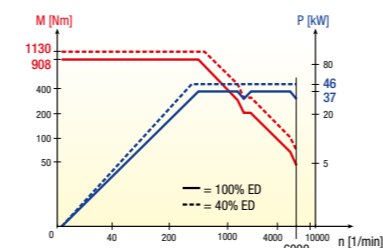

Geared spindle with 100 mm bearing diameter for NBH 630 / 800 / 1000 / 1200

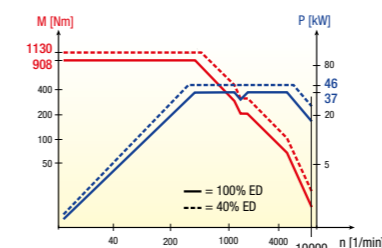

Geared spindle with 100 mm bearing diameter for NBH 6 / 6+ / 630 / 800 / 1000 / 1200

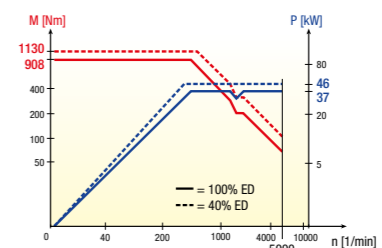

Geared spindle with 120 mm bearing diameter for NBH 800 / 1000 / 1200

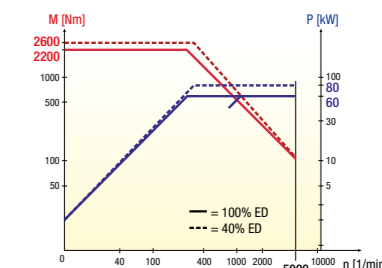

Geared spindle with 130 mm bearing diameter for NBH 800 / 1000 / 1200

Horizontal machining center	type	NBH 5	NBH 500	NBH 6	NBH 630	NBH 800	NBH 1000	NBH 1200
<b>Motor spindle</b>								
Diameter in front bearing	mm	80	80	100	100	100	100	-
Speed max.	rpm	10 000	[16 000]	8000	[12 000]	8000	[12 000]	-
Spindle power 100% / 40% duty	kW	28/39	40/52	40/52	54/66	54/66	54/66	54/66
Torque 100% / 40% duty	Nm	126/180	95/125	126/180	95/125	300/370	300/370	300/370
Tool taper (DIN 69871)	SK	-	-	40	-	50	-	50
Tool taper (DIN 69893)	HSK	63	63	[63]	63	[100]	100	[100]
Tool taper (ANSI)	ANSI	-	-	[40]	-	[50]	-	[50]
<b>Geared spindle</b>								
Diameter in front bearing	mm	-	80	100	100	100	120	130
Speed max.	rpm	-	[10 000]	[10 000]	[6000]	[10 000]	[6000 o. 10 000]	[5000]
Spindle power 100% / 40% duty	kW	-	22,5 (100% ED)	37/46	37/46	37/46	37/46	60/80
Torque 100% / 40% duty	Nm	-	466 (100% ED)	908/1130	908/1130	908/1130	908/1130	2200/2600
Tool taper (DIN 69871)	SK	-	40	50	50	50	50	-
Tool taper (DIN 69893)	HSK	-	[63]	[100]	[100]	[100]	[100]	100
Tool taper (ANSI)	ANSI	-	[40]	[50]	[50]	[50]	[50]	-

[...] = option Subject to change without notice



# 5-AXIS OPTIONS

## SWIVEL HEAD

### SWIVEL HEAD FOR SIMULTANEOUS 5-AXIS MACHINING

For demanding machining operations, e.g. for contoured shapes and complex geometries in the areas of die and mold machining or the aerospace industry, the machine can be equipped with a swivel head.

Advantages:

- Reduction in unit costs due to complete 5-sided machining in one clamping
- Extraordinary chip removal volume when roughing and high surface quality when finishing thanks to extremely high retention forces in the rotary axes
- Extremely high dimensional stability of the workpiece due to thermally stable machine with standard configuration
- Large range of workpieces, materials from light metals to titanium and inconel are possible, as is hard cutting
- High tool capacity and convenient set-up thanks to one-of-a-kind tool magazine technology
- Perfect ergonomic accessibility during operation and maintenance
- Self-contained unit for quick and easy transportation, rigging and set-up

### TECHNOLOGICAL FEATURES OF THE SWIVEL HEAD

- High holding torque during simultaneous machining thanks to innovative electro-mechanical gear technology in swivel head and NC rotary table
- High maintained precision due to standard precision package for minimizing temperature affects such as cooled servo engines, ball screw nuts, gears and com-

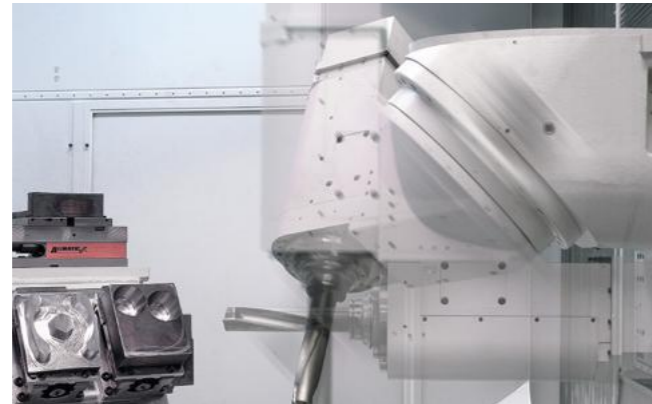

pensation for spindle displacement

- Optimized machine bed, chip removal to the rear
- New, dual-walled, closed and extremely stable machine base
- Workpiece loading during machining cycle via 180° pallet changer
- Optional direct loading of the machine without pallet changer, optimal use as system machine in powertrain segment
- Modular tool magazines available for a great variety of production requirements, ranging from 60 to 300 positions

### TECHNICAL DATA NBH 630 5X/NBH 800 5X

Swivel head with working spindle		
Swivel range (horizontal = 0°)	deg	0 up to -225
Positioning error (DIN ISO 230-2)	arc s.	10
Rapid traverse swivel axis	rpm	40
Speed range max.	rpm	10 000
Power 100% / 40% duty	kW	30/38
Torque 100% / 40% duty	Nm	286/378
Tool tapers		HSK 100
Max. tool diameter	mm	125
... adjacent tool locations empty	mm	325
Max. tool length <sup>1)</sup>	mm	480/800 <sup>2)</sup>
Tool weight	kg	40
Tilting moment	Nm	50
Internal coolant supply spindle [option]	bar	40 [70]

[...] = option

1) = in combination with tool cassette magazine

2) = possible collision with the maximum interference circle diameter of the fixture

Subject to change without notice

# 5-AXIS OPTIONS

## TILTING/ROTARY TABLE

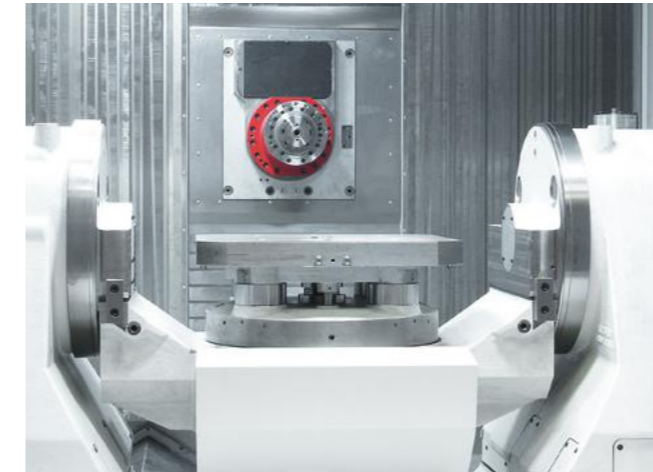

### TILTING/ROTARY TABLE FOR SIMULTANEOUS 5-AXIS MACHINING

The tilting/rotary table (B- on A-axis) is particularly suitable for heavy machining of complex workpieces from 5 sides, with bores and areas in different solid angles and freeform surfaces.

- Complete machining in one clamping (5-sided machining in one clamping)
- Use as positioning axis or for simultaneous machining
- High swivelling moment and feed rate in A-axis through backlash-free double worm gear drive
- All proven NBH working spindles with high torque and performance for highest accuracy requirements can be used

### TECHNICAL DATA TILTING/ROTARY TABLE

		NBH 800	NBH 1000
Pallet size	mm	800x800	1000x1000
Fixture height	mm	1100 [1400]	1400
Swing circle diameter	mm	1200	1600
Pallet load / table load	kg	1200/ 1500	2500
Swivelling range A-axis	deg	-30 bis +120	-30 bis +120
Swivelling range B-axis	deg	360	360
Smallest fraction	deg	0,001	0,001

[...] = option

Subject to change without notice

# MODULAR TOOL MAGAZINES

FULL RANGE OF OPTIONS FOR SMALL BATCHES OR HIGH VOLUMES

Individual tool magazine solutions to match your production requirements. The NBH range offers a variety of tool magazines optimally adapted to your production.

- Pick-up disc-type magazine, 40 tool locations
- Disc-type magazine, 60 or 120 tool locations
- Chain magazine, 32, 60 or 90 tool locations
- Rack-type or cassette magazine

## 1 Pick-up disc-type magazine

- Proven, reliable and cost-effective
- Fast pick-up tool change into the spindle
- Steel tool holder brackets

## 2 Disc-type magazine

- Tool storage with special double clamps
- NC controlled, highly accurate positioning of the disc
- Fast tool allocation via linear tool handling device with NC drive during machining time

## 3 Chain magazine

- 32, 60 or 90 tool locations
- Fast electromechanical tool changer with automatic mechanical locking when swivelling

## 4 Tool cassette magazine

- In-process re-setting of complete tool sets
- Tool loading station or tool drawer for inward and outward in-process transfer of single (worn-out) tools
- No affecting of tools by coolant and chips due to the overhead arrangement
- Location-coded tools with electronic management
- Special tool cassettes for large tools increase flexibility

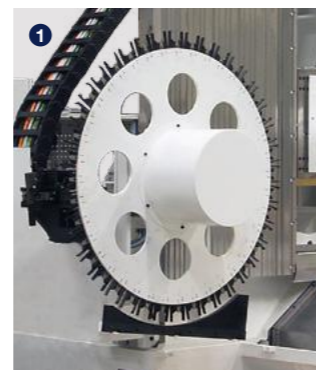

# TECHNICAL DATA

Horizontal machining center	type	NBH 5	NBH 500	NBH 6	NBH 630	NBH 800	NBH 1000	NBH 1200
<b>Tool disc magazine, location</b>	number	40	40	60 or [120]	60 or [120]	60 or [120]	60 or [120]	–
Max. tool diameter	mm	80	80	125	125	125	125	–
... adjacent tool locations empty	mm	150	210	250	325	325	325	–
Max. tool length	mm	450/500 <sup>1)</sup>	450/550	450 [540]	600	600	600	–
Max. tool weight	kg	10 [12]	12	25	40	40	40	–
Max. tilting moment	Nm	8	15	25	50	50	50	–
Chip-to-chip time (VDI 2852)	approx. s	3,9	3,8	3,5 [3,3]	3,2	4,0	5,7	–
<b>Tool chain magazine, location</b>	number	[32] [60] [90]	[60] [90]	–	–	–	–	–
Max. tool diameter	mm	80	80	–	–	–	–	–
... adjacent tool locations empty	mm	165	175	–	–	–	–	–
Max. tool length	mm	450/500 <sup>1)</sup>	550	–	–	–	–	–
Max. tool weight	kg	12	12	–	–	–	–	–
Max. tilting moment	Nm	8	12	–	–	–	–	–
Chip-to-chip time (VDI 2852)	approx. s	3,2 [2,1] <sup>2)</sup>	3,6 (3,7)	–	–	–	–	–
<b>Tool cassette magazine, location</b>	number	–	[168] [252] [294]	–	[150] [200] [300]	[150] [200] [300]	[150] [200] [300]	100 [150] [200] [300] [400]
Tool loading/unloading station [drawer]	number	–	1 [4] 1 [7] 1 [7]	–	1 [4]	1 [4]	1 [4]	1 [4]
Tool cassette	number	–	3 3 4	–	[3] [4] [6]	[3] [4] [6]	[3] [4] [6]	2 [3] [4] [6] [8]
Max. tool diameter	mm	–	100 95 95	–	125	125	125	125
... adjacent tool locations empty	mm	–	250 175 175	–	325 [400] <sup>3)</sup>	325 [400] <sup>3)</sup>	325 [400] <sup>3)</sup>	325
Special tools (diameter x width x length)	mm	–	– – –	–	600x125x550	600x125x550	600x125x550	–
Max. tool length	mm	–	550 550 550	–	800	800	800	650
Max. tool weight	kg	–	25 12 12	–	40 [50]	40 [50]	40 [50]	40
Max. tilting moment	Nm	–	25 15 15	–	50 [100]	50 [100]	50 [100]	50
Chip-to-chip time (VDI 2852)	approx. s	–	5,0 3,9 3,9	–	3,3	4,0	5,7	9,0

[...] = option

1) = when direct loading

2) = optional speed package and 32-chain magazine

3) = only in special cassette

Subject to change without notice

# NUMERICAL CONTROLS

## BASIC STRUCTURE OF THE CNC CONTROL SINUMERIK 840D SL

- High-performance, modular 32-bit microprocessor CNC path control
- Digital drive technology
- Space-coded or absolute position measuring systems
  - Vanishing referencing time
  - Neither axis limit switches nor reference switches
- WINDOWS user surface
  - NC operating panel, 12" TFT color display with integrated NC keyboard and machine operator panel
  - Comfortable setting up due to tool magazine operator panel
- Extended CNC functionalities
  - Tool management with automatic twin tool strategy
  - Monitoring of tool life quantities
  - "Safety Integrated Software" for safe and practice-oriented set-up works with guard doors opened
- Ethernet and USB connection as standard

## DIAGNOSTIC FUNCTIONS

- Site log: plaintext error messages
- Machine and production data acquisition [option]
- Remote diagnosis and remote maintenance [option]

## PLANNING FUNCTIONS [option]

- Tool master data
- NC program master data
- Availability control
- Tool difference lists



Interactive space requirement determination by the tool administration function. Ideal utilization of the tool magazine capacity by automatic collision observation of neighbouring locations on a millimeter basis



Clearly structured, graphical tool administration of the tool rack-type cassette magazine

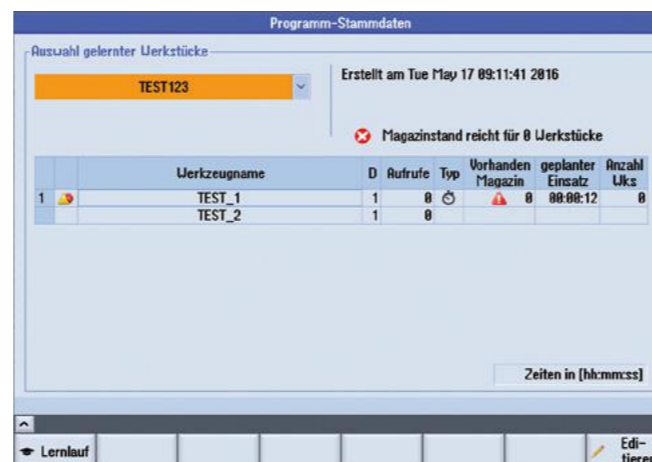

The optional convenience package allows the tool budget to be planned over several workpieces

# AUTOMATION

For the purpose of multiple machine assignment, continuation of production during breaks as well as for unmanned production, all NBH machining centers can be equipped with

- Multi-pallet storage system (MPS)
- Linear pallet container (LPC)
- Linear and multi-level pallet storage system
- Multi-pallet handling system (MPH)
- Robot and gantry loader automation

These optimized modules for flexible production cells and systems are tailored to fit specific production needs and can be equipped with a wide range of processing technology.



Very compact multi-pallet storage system (MPS) to deposit the pallets at 2 levels with space-saving installation surface for NBH 630.



Part view of fully automatic manufacturing line for machining of gearboxes. Further details see text on the right.

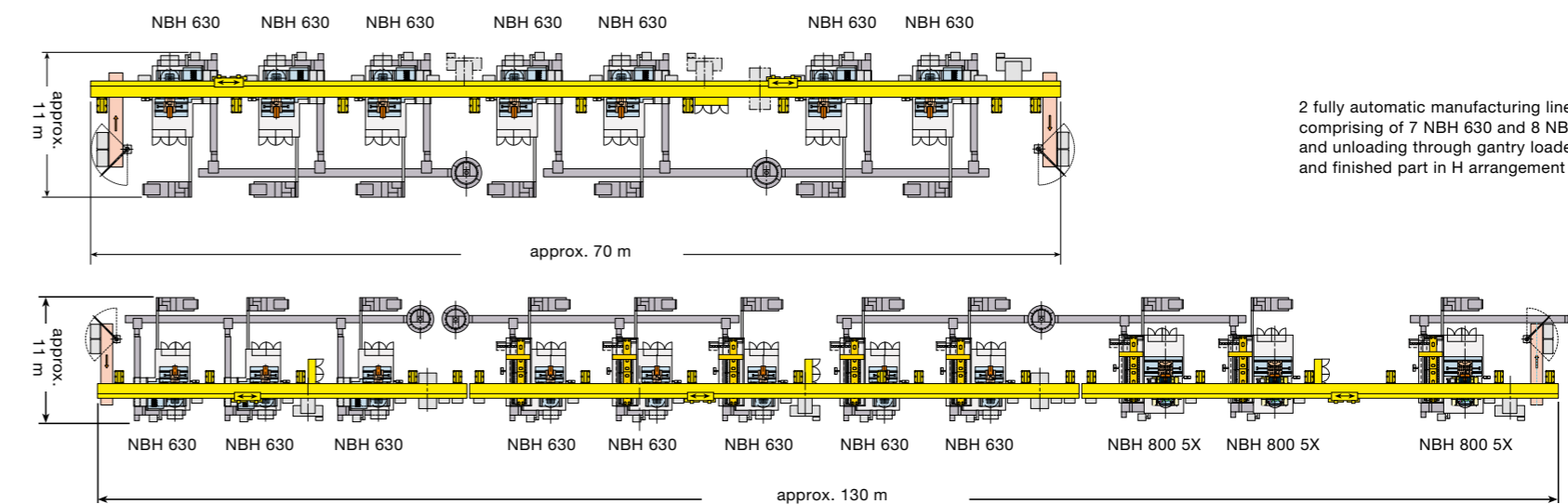

2 fully automatic manufacturing lines for machining gear cases (GG25) comprising of 7 NBH 630 and 8 NBH 630 plus 3 NBH 800 5X. Direct loading and unloading through gantry loader. A carriage with double gripper for raw and finished part in H arrangement ensures short loading/unloading cycle.

# PROCESS TECHNOLOGY OPTIONS

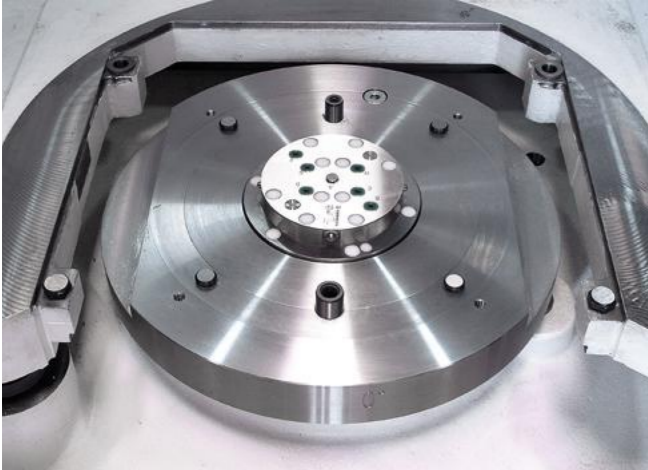

**HYDRAULIC CLAMPING**  
2-line or 6-line hydraulic clamping for actuation in the set-up station or work area. Pneumatic version available.

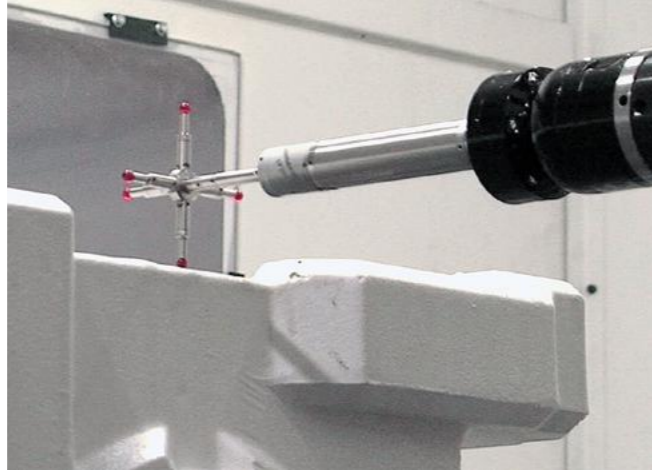

**WORKPIECE MEASURING**  
Measuring probe with infrared transfer of the measured values for the in-process measuring of workpieces and/or clamping fixtures. The tool handling equipment automatically loads the measuring probe into the spindle.



**TOOL MONITORING**  
The tool monitoring may be upgraded individually up to a complete safety package particularly for the unmanned production.

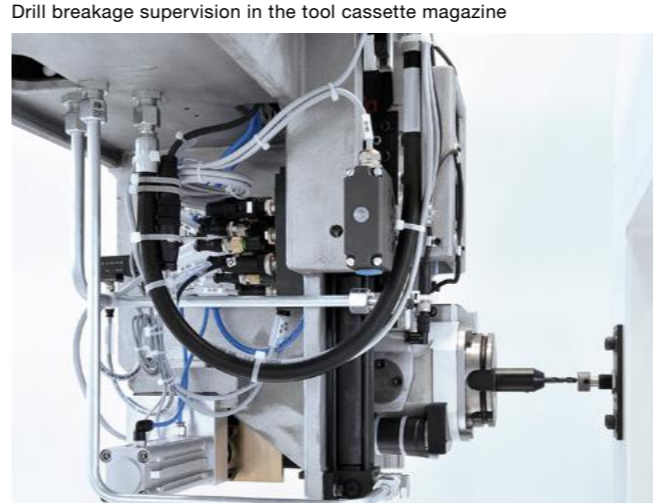

**HÜLLER HILLE TOOL MANAGEMENT**

- Tool life quantities monitoring with automatic exchange for twin tools
- In-process tool breakage monitoring in the tool magazine area

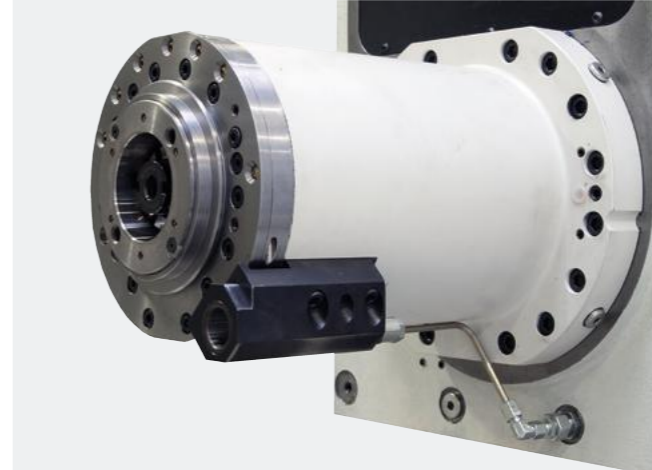

**DRILLING/MILLING HEAD INTERFACE**  
A special interface can be applied to add capacities for angled drilling heads, multi-spindle tools or threading devices for reduced manufacturing costs.

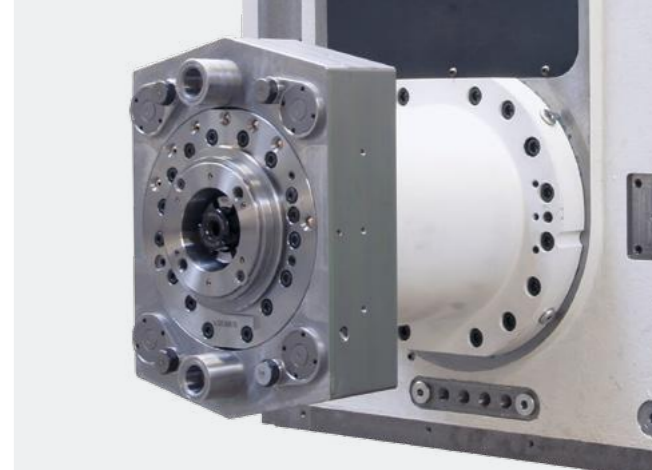

**FOURFOLD DRILL AND MILLING HEAD CLAMPING**  
For heavy drill and milling heads (up to 50 kg) for transmission of high torques and cutting capacity.

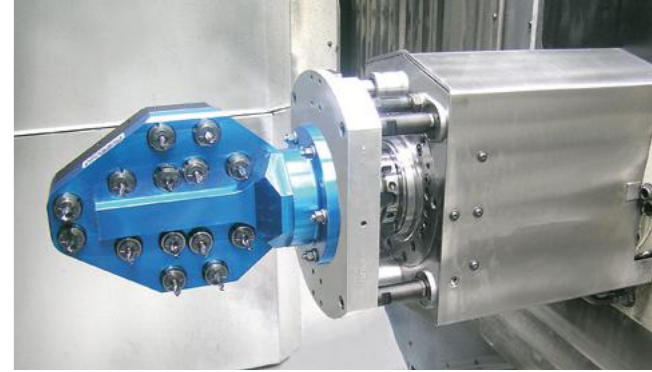

Example: Multi-spindle drill head for simultaneous machining of 14 bores.

# NBH 5

## MAIN DIMENSIONS AND WORKING AREA

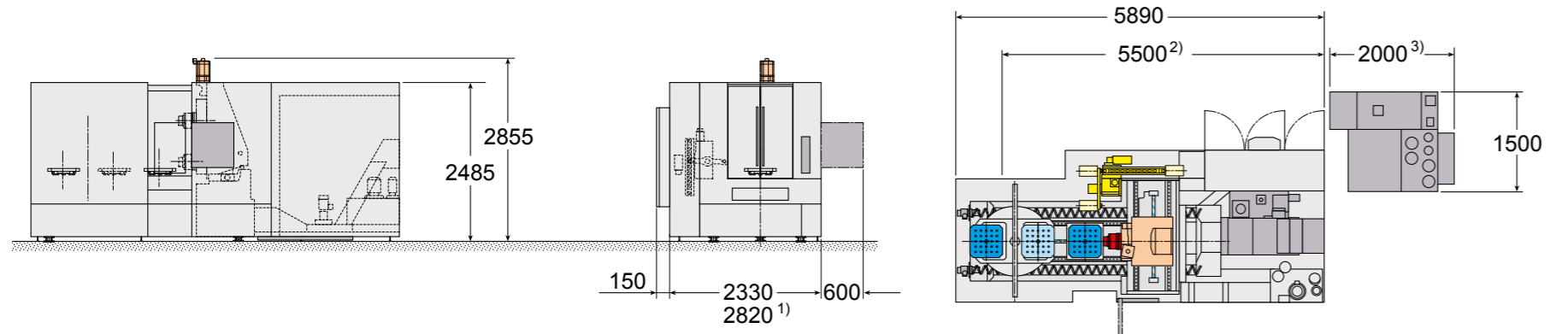

- 1) = NBH 5 with disc magazine
- 2) = NBH 5 with direct loading and without pallet changer
- 3) = Coolant system, variable installation

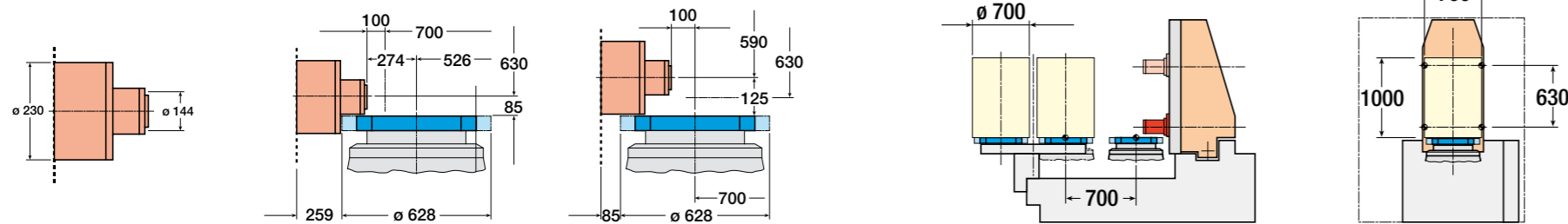

Subject to change without notice

# NBH 500

## MAIN DIMENSIONS AND WORKING AREA

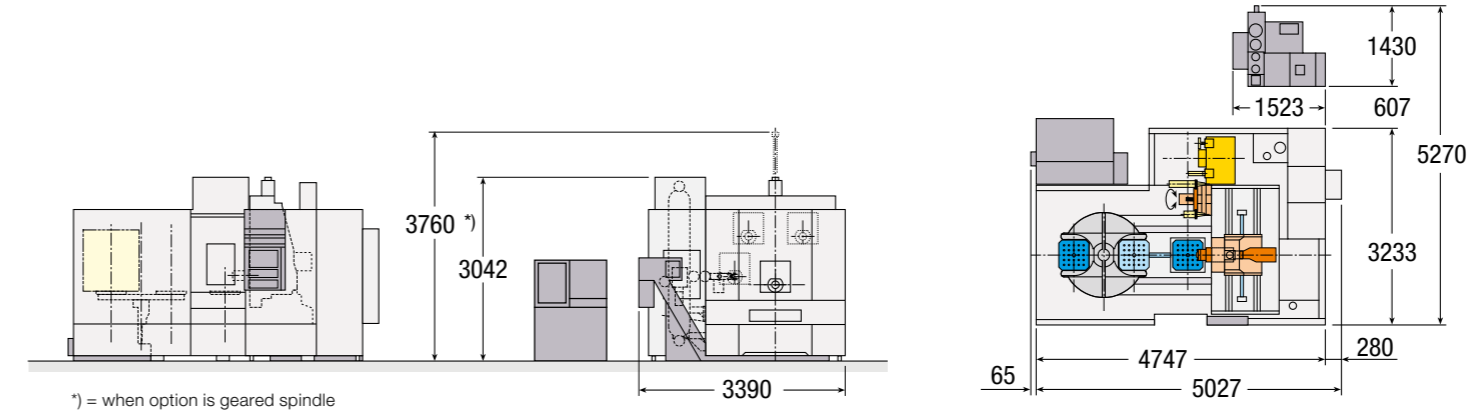

\*) = when option is geared spindle

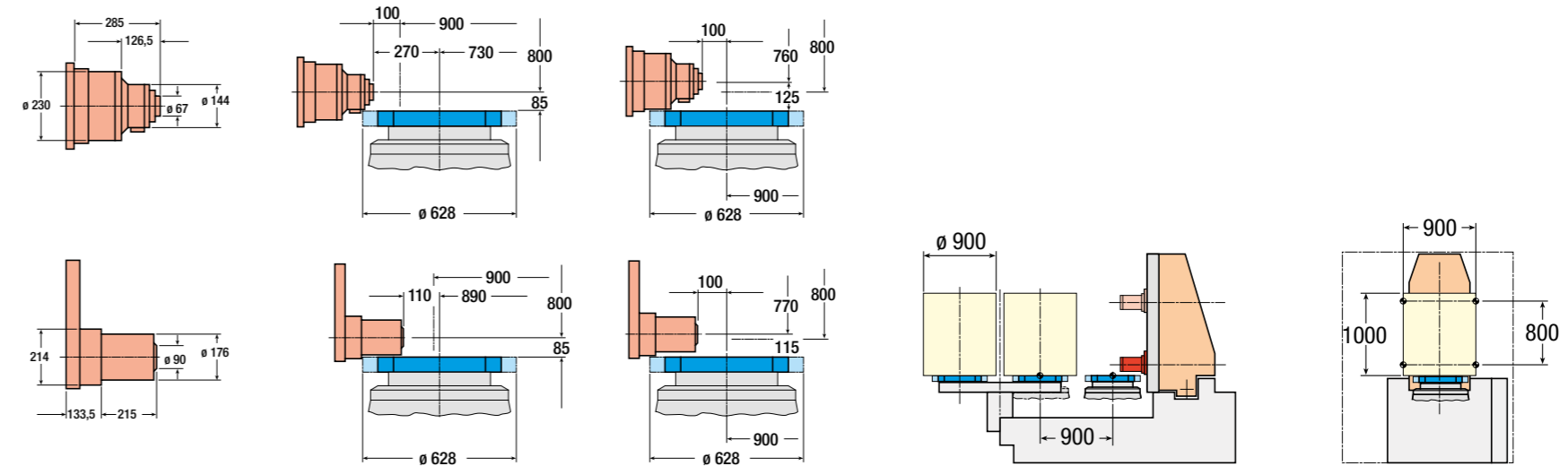

Subject to change without notice

# NBH 6

## MAIN DIMENSIONS AND WORKING AREA

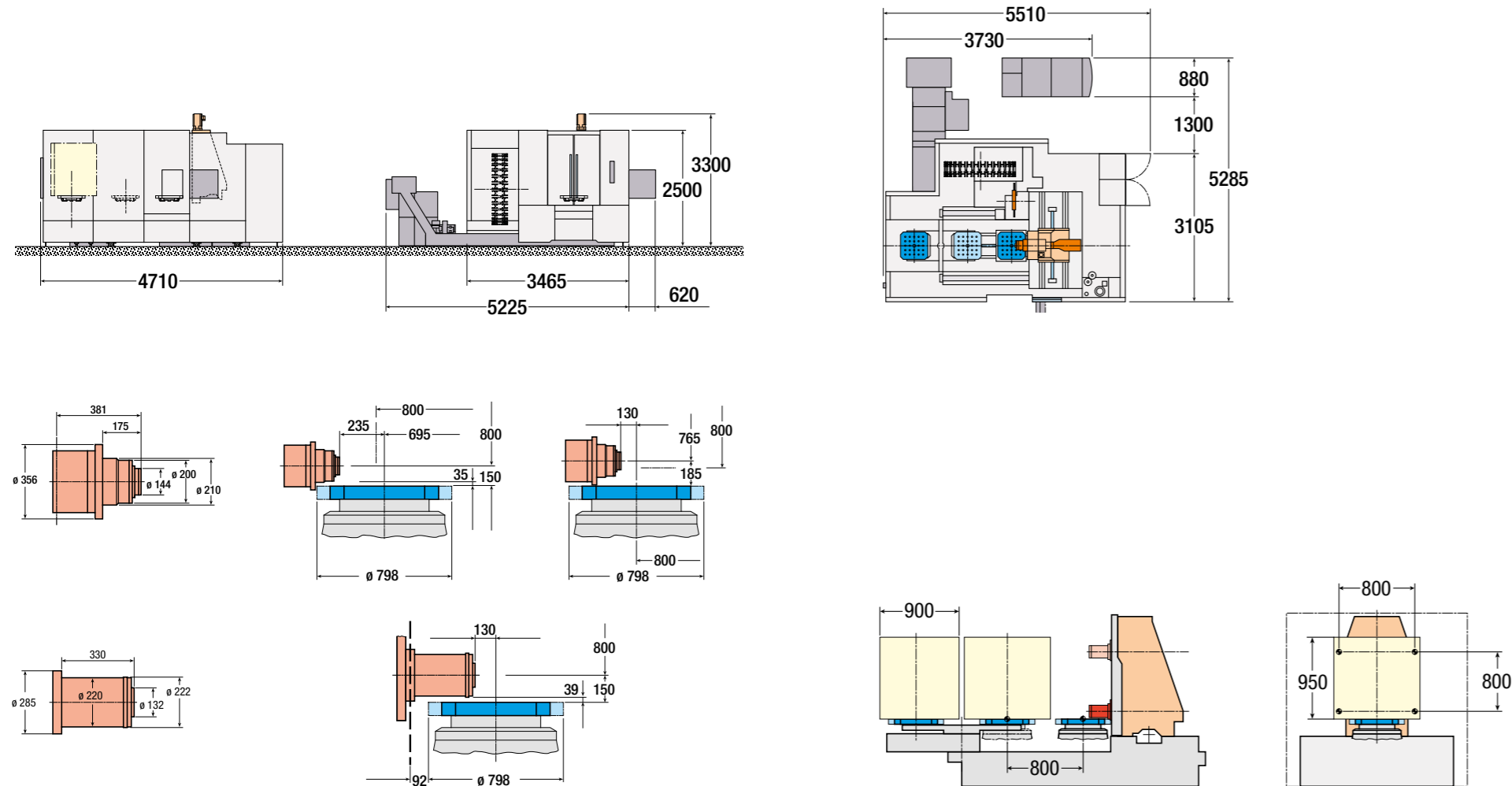

Subject to change without notice

# NBH 630

## MAIN DIMENSIONS AND WORKING AREA

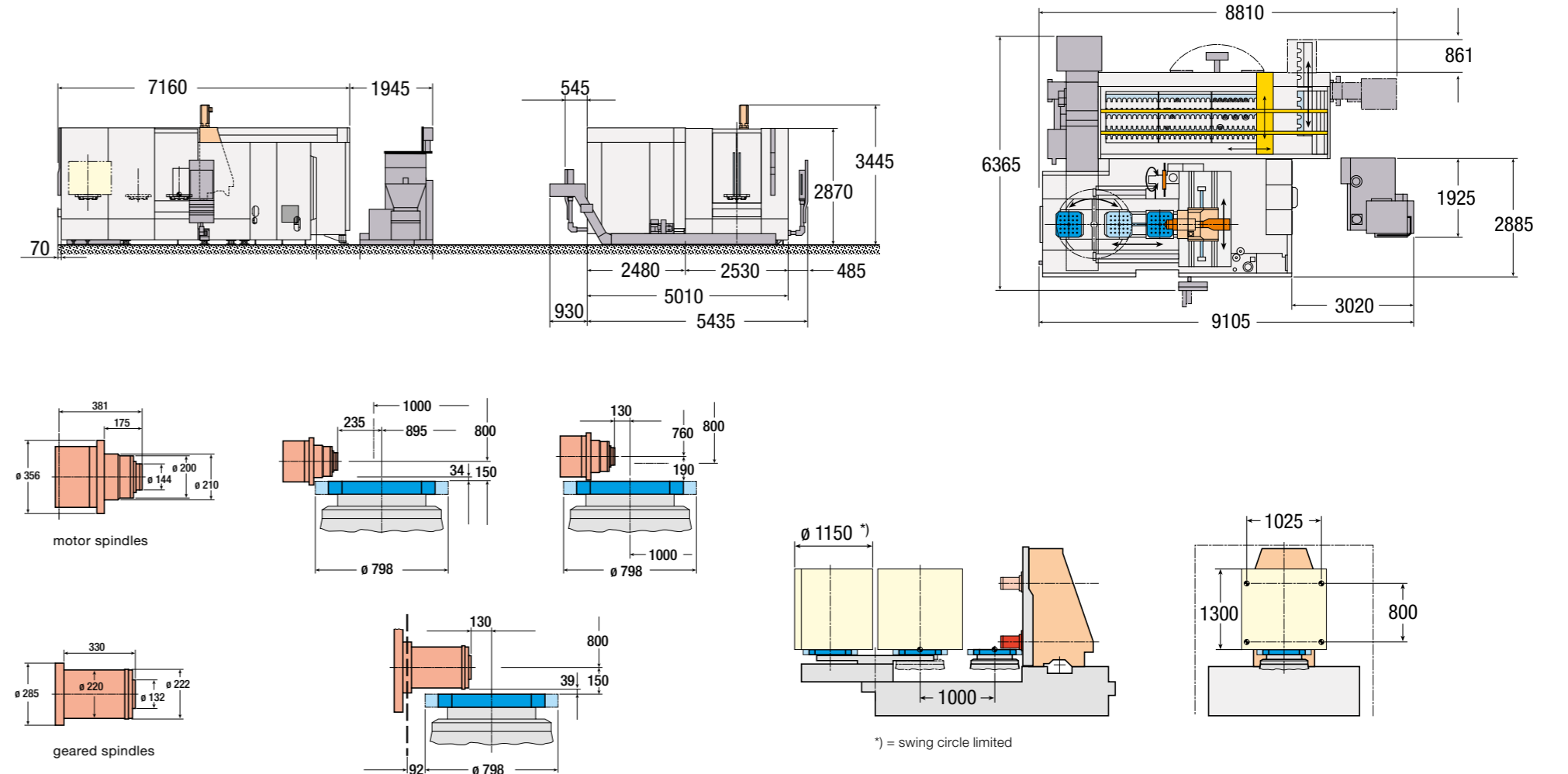

\*) = swing circle limited

Subject to change without notice

# NBH 800/1000

## MAIN DIMENSIONS AND WORKING AREA

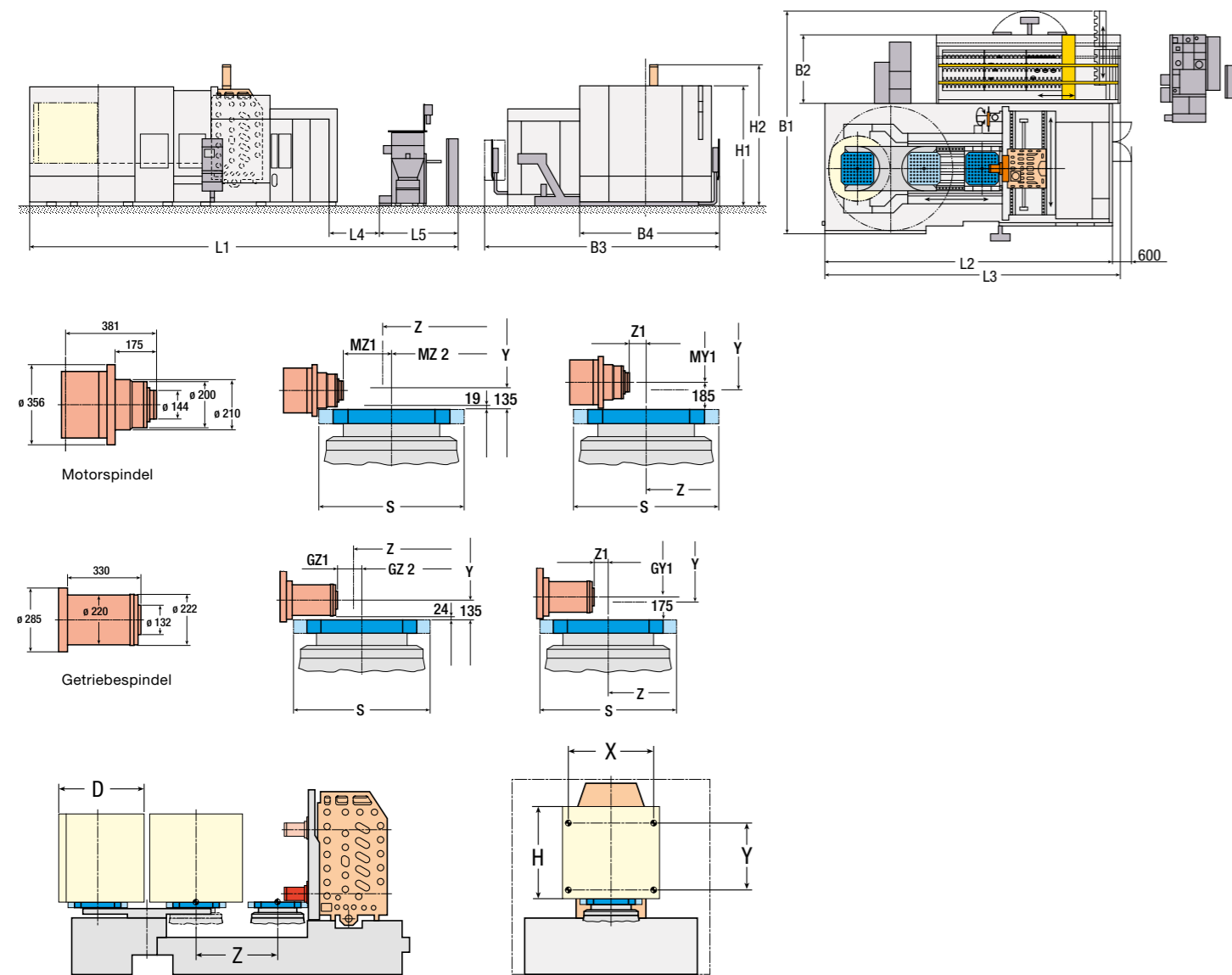

Maschine	type	NBH 800	NBH 1000
L 1	approx. mm	11 275	12 965
L 2	approx. mm	7985	9090
L 3	approx. mm	7985	-
L 4	approx. mm	1500	1500
L 5	approx. mm	1790	2375
B 1	approx. mm	6025	7020
B 2	approx. mm	2130	2130
B 3	approx. mm	6615	7245
B 4	approx. mm	3590	4240
H 1	approx. mm	3565	3565
H 2	approx. mm	3867	4222

Maschine	type	NBH 800	NBH 1000
S pallet swing circle	ø mm	1000	1250
Z-stroke	mm	1400	1800
Z 1	mm	112,5	237,5
MZ 1	mm	335	457,5
MZ 2	mm	1177,5	1580
Y-stroke	mm	1100	1400
MY 1	mm	1050	1350

Maschine	type	NBH 800	NBH 1000
S pallet swing circle	mm	1000	1250
Z-stroke	mm	1400	1800
Z 1	mm	112,5	237,5
GZ 1	mm	175,5	622,5
GZ 2	mm	1337	1415
Y-stroke	mm	1100	1400
GY 1	mm	1060	1360

Maschine	type	NBH 800	NBH 1000
X-stroke	mm	1400	1800
Y-stroke	mm	1100	1400
Z-stroke	mm	1400	1800
H	mm	1500	1800
D swing circle	ø mm	1600	2000

Subject to change without notice

# NBH 1200

## MAIN DIMENSIONS AND WORKING AREA

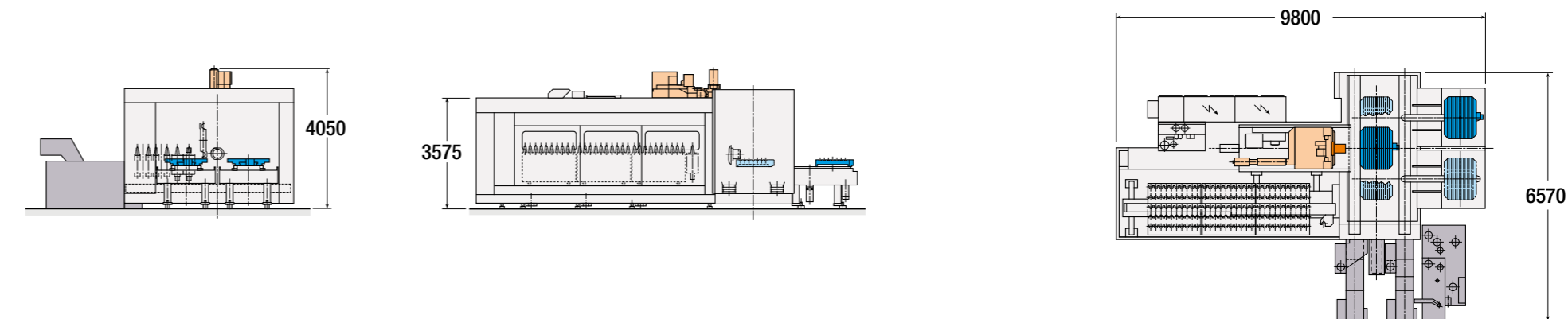

NBH 1200 with 3 tool cassettes as an option, 2 tool cassettes are standard.

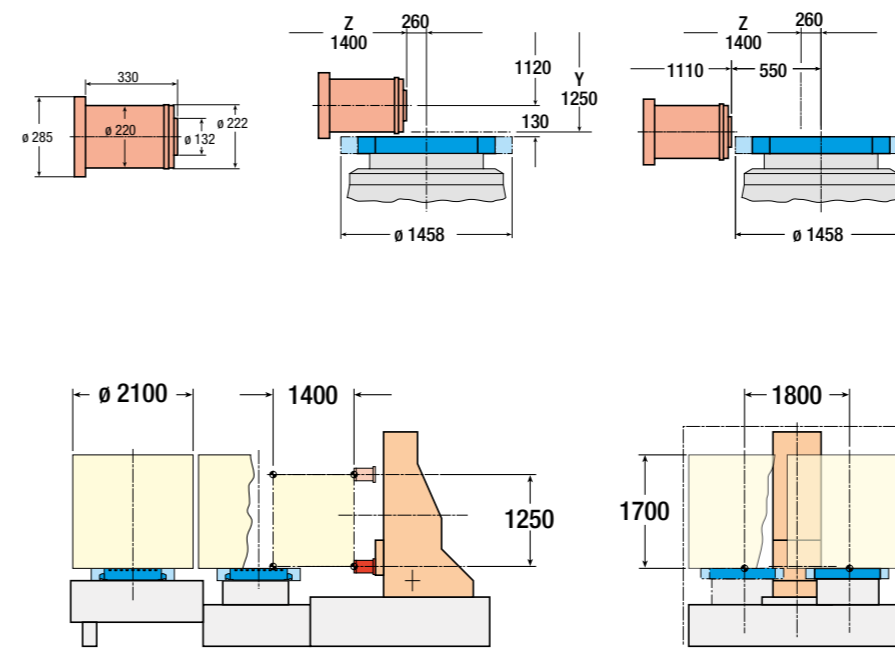

Subject to change without notice

# TECHNICAL DATA

## NBH RANGE

Horizontal machining center	type	NBH 5	NBH 500	NBH 6	NBH 630	NBH 800	NBH 1000	NBH 1200								
<b>Working range</b>																
Travel X-axis	mm	700	900	800	1025	1400	1800	1800 [2600]								
Travel Y-axis	mm	630	800	800	800 [1000]	1100 [1400]	1400	1250 [1600]								
Travel Z-axis	mm	700	900	800	1000	1400	1800	1400 [1780]								
Swing circle diameter / limited	mm	700 (800) <sup>2)</sup>	900	900	900/1150	1300/1600	1700/2000	2100 [2400] [2800]								
Fixture height	mm	1000	1000	950	1300	1500 [1800]	1800	1700								
<b>Position measuring system</b>	type	direct	direct	direct	direct	direct	direct	direct								
Integrated in profile way		standard	standard	standard	standard	–	–	–								
Glass scales		standard <sup>2)</sup> [option]	standard <sup>2)</sup> [option]	[option]	[option]	[option]	standard	standard								
Positioning error A (DIN ISO 230-2)	mm	0,007	0,007	0,007	0,007	0,007	0,007	0,010								
<b>Pallet / rotary table</b>																
Pallet size / clamping surface <sup>2)</sup>	mm	500x500/ø 500	500x500	630x630	630x630 [800x800]	800x800 [1000x1000]	1000x1000 [1000x1250]	1000x1250								
Pallet load max. / table load <sup>2)</sup>	kg	500/800	800	1000	1500	2000	3000	3500 [7000]								
Torque table, smallest fraction	deg	0,001	0,001	0,001	0,001	0,001	0,001	0,001								
Rotary speed B-axis	rpm	80	80	80	80	25	25	10								
Pallet change time VDI 2852	approx. s	9	12,5	12	13	20	25	80								
<b>Motor spindle</b>								–								
Speed max.	rpm	10 000	[16 000]	10 000	[16 000]	8000	[12 000]	8000	[12 000]	8000	[12 000]	8000	[12 000]	–		
Spindle power 100% / 40% duty	kW	28/39	40/52	28/39	40/52	54/66	54/66	54/66	54/66	54/66	54/66	54/66	54/66	–		
Torque 100% / 40% duty	Nm	126/180	95/125	126/180	95/125	300/370	300/370	300/370	300/370	300/370	300/370	300/370	300/370	–		
<b>Geared spindle</b>																
Speed max.	rpm	–	[10 000]	[10 000]	[10 000]	[6 000 o. 10 000]	[5 000]	[6 000 o. 10 000]	[5 000]	[5 000]	[6 000 o. 10 000]	[5 000]	[5 000]	[6 000 o. 10 000]	[5 000]	[5 000]
Spindle power 100% / 40% duty	kW	–	22,5 (100% ED)	37/46	37/46	37/46	37/46	37/46	60/80	37/46	37/46	60/80	37/46	60/80	37/46	60/80
Torque 100% / 40% duty	Nm	–	466 (100% ED)	908/1130	908/1130	908/1130	908/1130	908/1130	2200/2600	908/1130	908/1130	2200/2600	908/1130	908/1130	2200/2600	
<b>Feed / rapid traverse</b>																
Feed force X- / Y- / Z-axis	approx. kN	15/9/15 [12/9/15] <sup>3)</sup>	15/10/15	10/10/12	15/15/20	20/10/20	20/10/20	25								
Feed range X- / Y- / Z-axis	mm/min	0–65 000 [0–90 000] <sup>3)</sup>	0–65 000	0–50 000 [0–65 000]	0–70 000	0–60 000/0–60 000 [0–40 000] <sup>1)/0–60 000</sup>	0–40 000	0–40 000								
Rapid traverse X- / Y- / Z-axis	m/min	65 [90] <sup>3)</sup>	65	50 [65]	70	60/60 [40] <sup>1)/60</sup>	40	40								
Acceleration X- / Y- / Z-axis	m/s <sup>2</sup>	8 [10] <sup>3)</sup>	8	5	7	6/6 [4] <sup>1)/6</sup>	4	2,5/5/4,5								
<b>Tool disc magazine, location</b>	number	40	40	60 or [120]	60 or [120]	60 or [120]	60 or [120]	–								
Max. tool diameter	mm	80	80	125	125	125	125	–								
... adjacent tool locations empty	mm	150	210	250	325	325	325	–								
Max. tool length	mm	450/500 <sup>2)</sup>	550	450 [540]	600	600	600	–								
Max. tool weight	kg	10 [12]	12	25	40	40	40	–								
Chip-to-chip time (VDI 2852)	approx. s	3,9	3,8	3,5 [3,3]	3,2	4,0	5,7	–								
<b>Tool chain magazine, location</b>	number	[32] [60] [90]	[60] [90]	–	–	–	–	–								
Max. tool diameter	mm	80	80	–	–	–	–	–								
... adjacent tool locations empty	mm	165	175	–	–	–	–	–								
Max. tool length	mm	450/500 <sup>2)</sup>	550	–	–	–	–	–								
Max. tool weight	kg	12	12	–	–	–	–	–								
Chip-to-chip time (VDI 2852)	approx. s	3,0 [2,1] <sup>3)</sup>	3,6 (3,7)	–	–	–	–	–								
<b>Cassettenmagazin</b>	Art	–	[cassette]	–	[cassette]	[cassette]	[cassette]	cassette								
Tool loading/unloading station [drawer]	number	–	1 [4] 1 [7] 1 [7]	–	1 [4]	1 [4]	1 [4]	1 [4]								
Tool cassette	number	–	3 3 4	–	[3] [4] [6]	[3] [4] [6]	[3] [4] [6]	2 [3] [4] [6] [8]								
Tool location	number	–	[168] [252] [294]	–	[150] [200] [300]	[150] [200] [300]	[150] [200] [300]	100 [150] [200] [300] [400]								
Max. tool diameter	mm	–	100 95 95	–	125	125	125	125								
... adjacent tool locations empty	mm	–	250 175 175	–	325 [400] <sup>4)</sup>	325 [400] <sup>4)</sup>	325 [400] <sup>4)</sup>	325								
Special tools (diameter x width x length)	mm	–	– – –	–	600x125x550	600x125x550	600x125x550	–								
Max. tool length	mm	–	550 550 550	–	800	800	800	650								
Max. tool weight	kg	–	25 12 12	–	40 [50]	40 [50]	40 [50]	40								
Chip-to-chip time (VDI 2852)	approx. s	–	5,0 3,9 3,9	–	3,3	4,0	5,7	9,0								
Machine weight	approx. kg	13 500 <sup>2)</sup> /14 500	14 500	18 000	24 000	32 000	35 000	43 000								

[...] = option

1) = when travel Y-axis is 1400 mm

2) = when direct loading

3) = optional speed package and 32-chain magazine

4) = only in special cassette

Subject to change without notice

All illustrations are exemplary.  
Actual form and version of machines  
may differ, depending on ordered type.



**ZUSE HÜLLER HILLE WERKZEUGMASCHINEN GMBH**

Steige 61, 74821 Mosbach, Tel. +49 6261 66-0, Fax +49 6261 66-369

[zuseautomation.com/huellerhille](http://zuseautomation.com/huellerhille)

143d/05/300/06-17

---

SHAPE PRODUCTS. NOT PRODUCTION.

